

Rahmen, Bautiefe 130mm-180mm,
10mm Fugenmaß

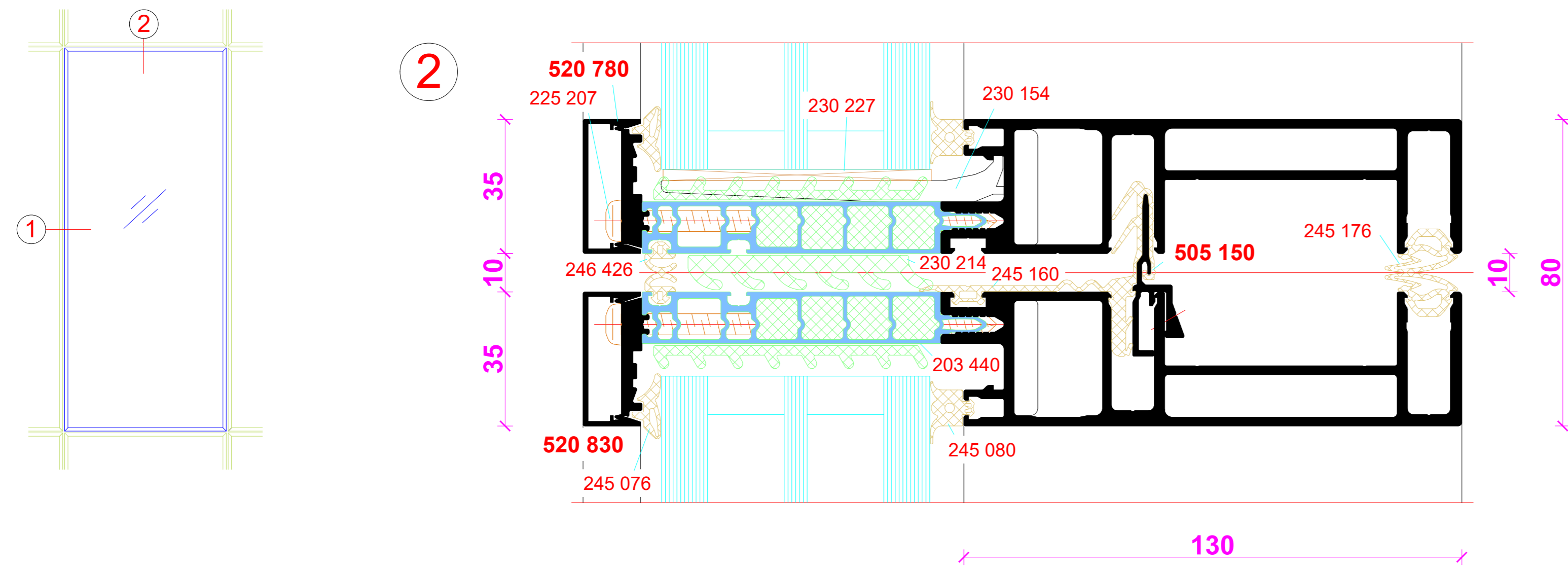

Rahmen, Bautiefe 130mm-180mm,
10mm Fugenmaß

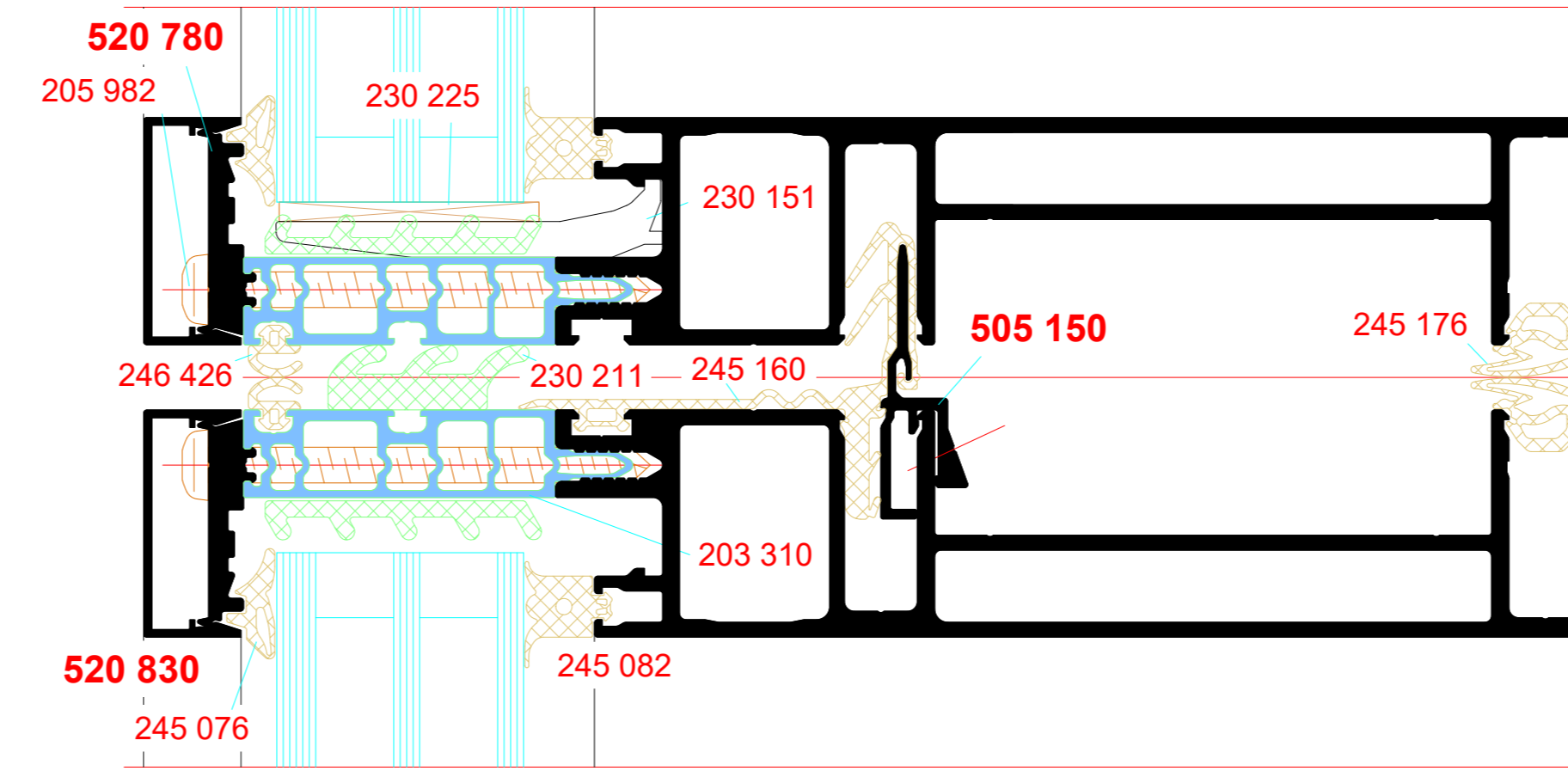

Rahmen, Bautiefe 130mm-180mm,
10mm Fugenmaß
mit Kopplungsdichtung

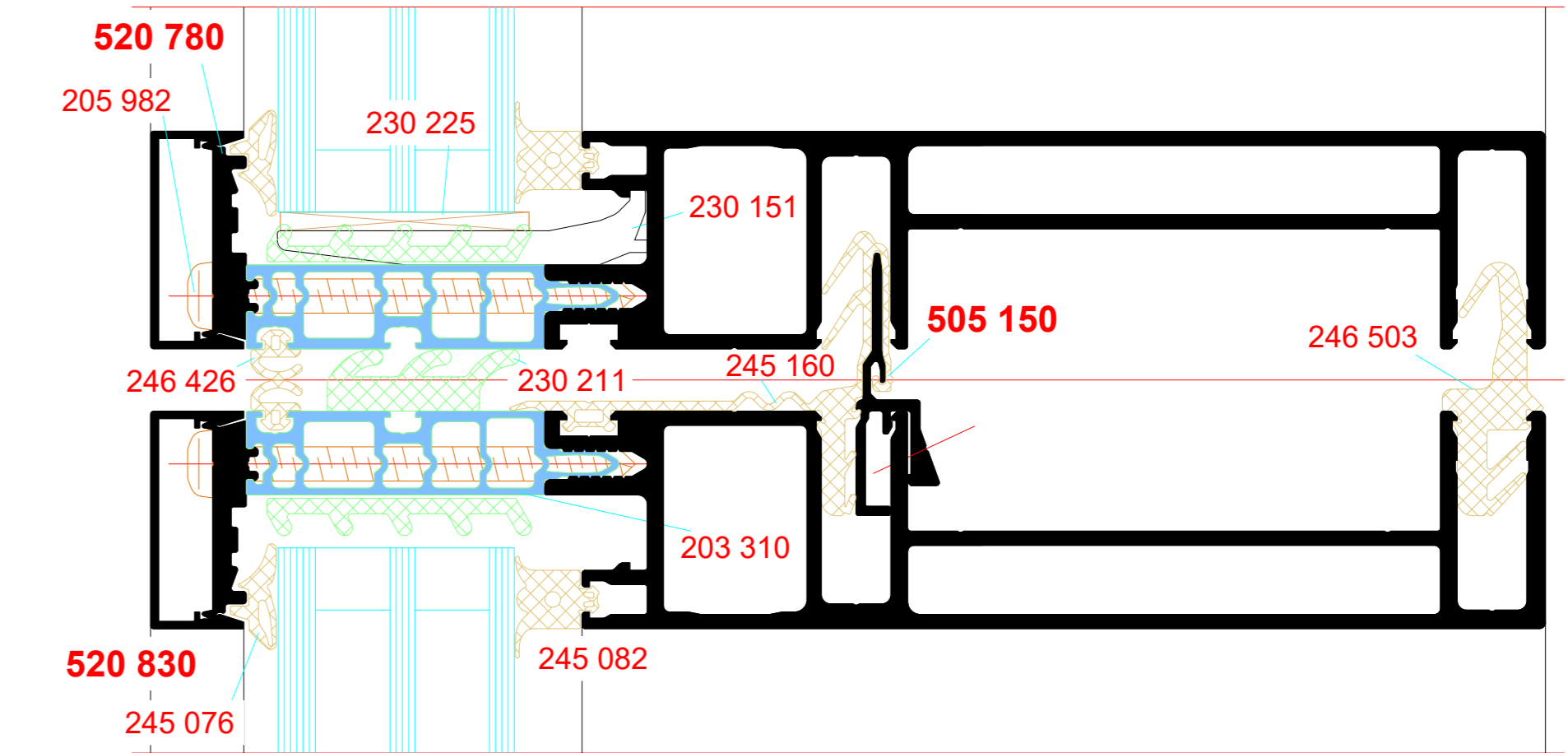

Rahmen, Bautiefe 130mm-180mm,
10mm Fugenmaß
mit Stoß-Abdeckprofil

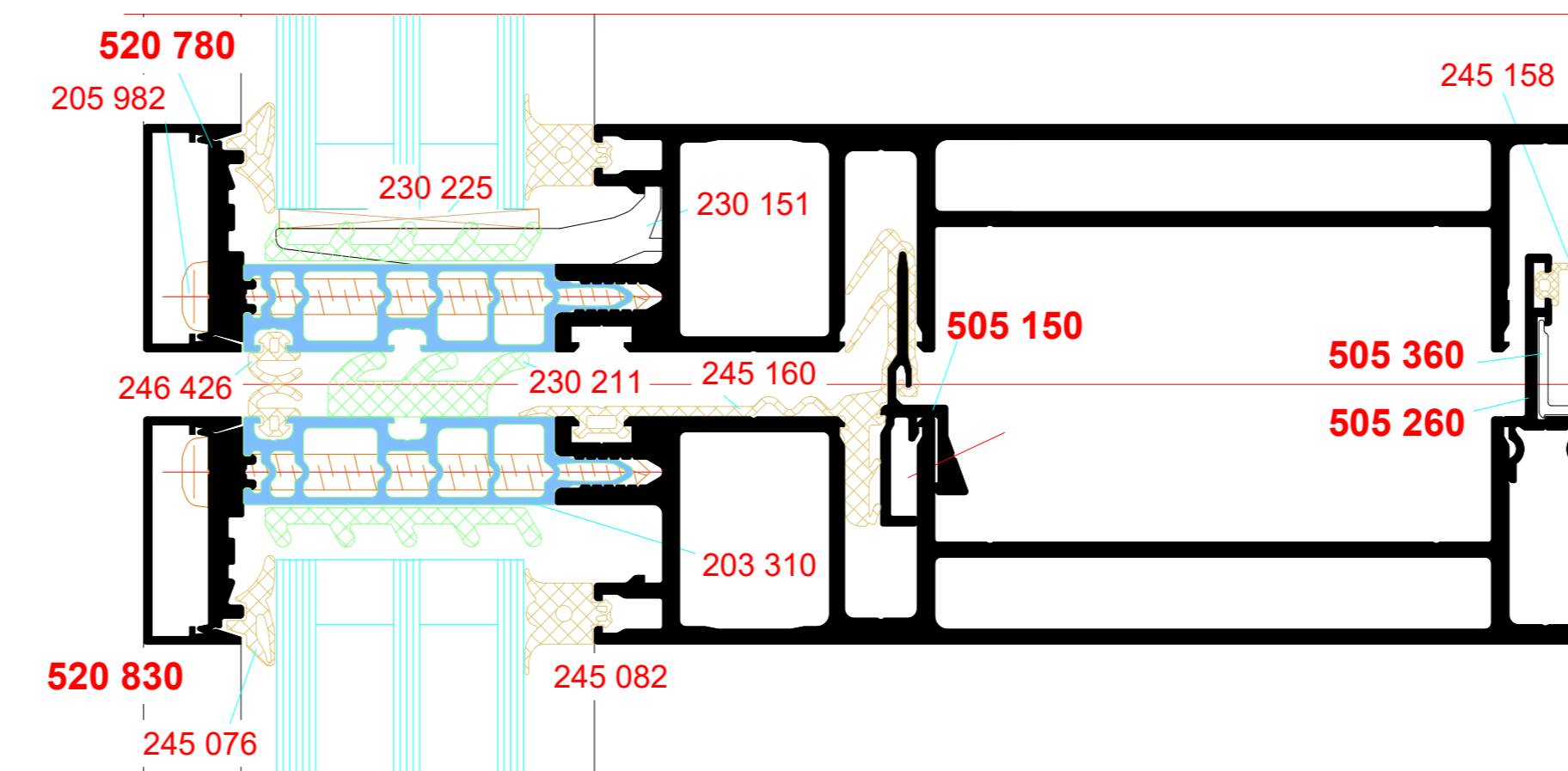

Rahmen, Bautiefe 130mm-180mm,
10mm Fugenmaß

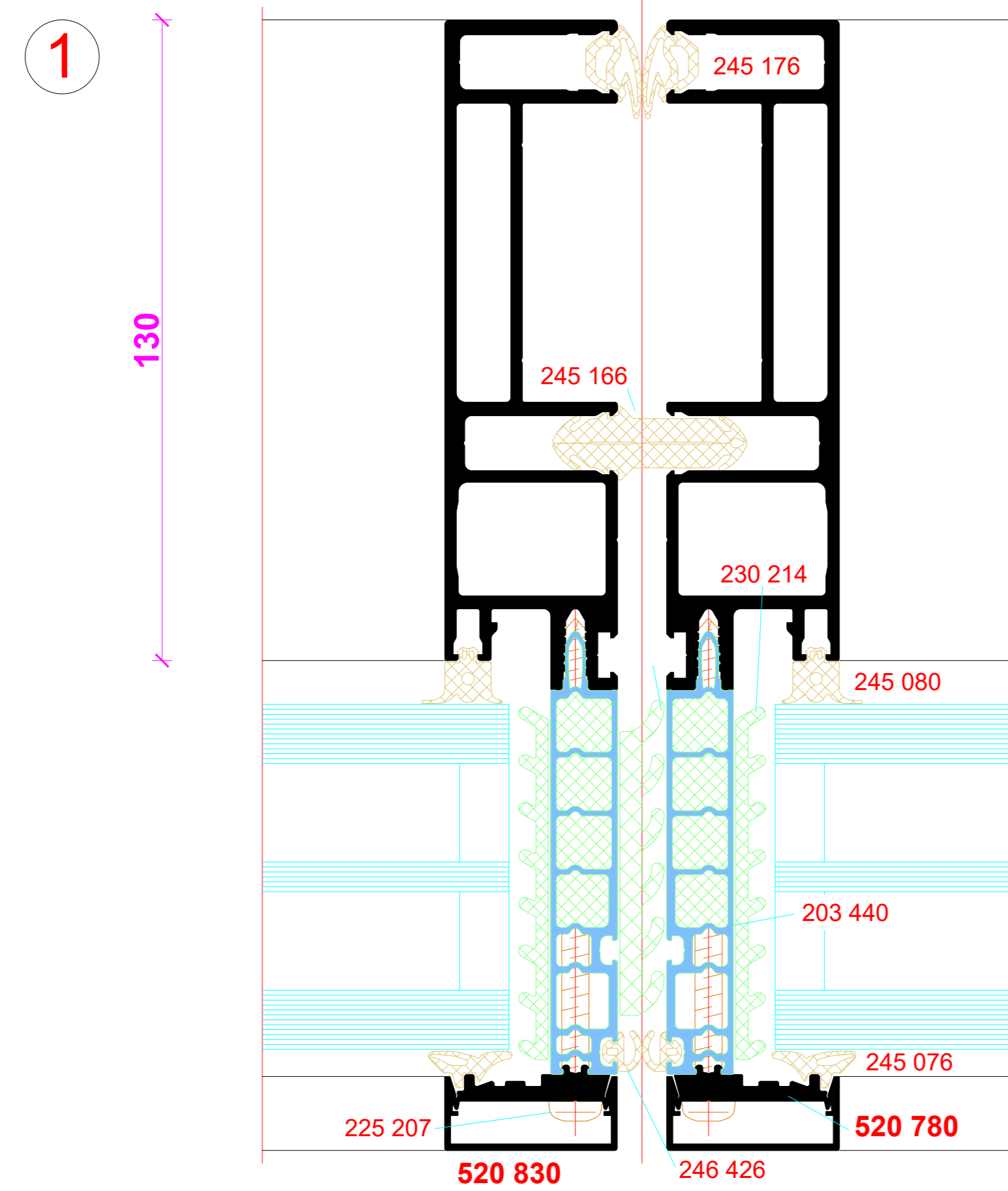

Rahmen, Bautiefe 130mm-180mm,
10mm Fugenmaß

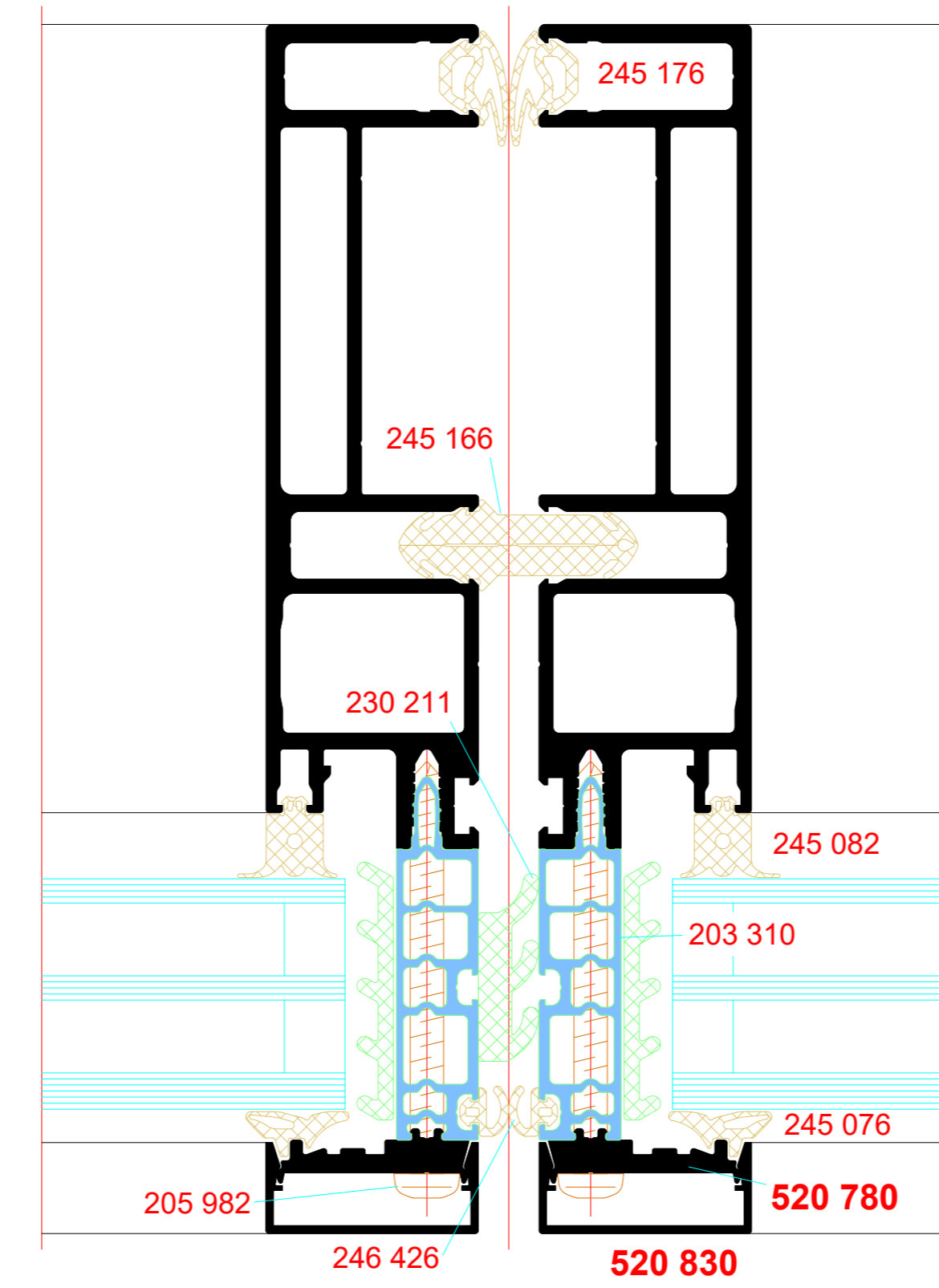

Rahmen, Bautiefe 130mm-180mm,
15mm Dehnfuge

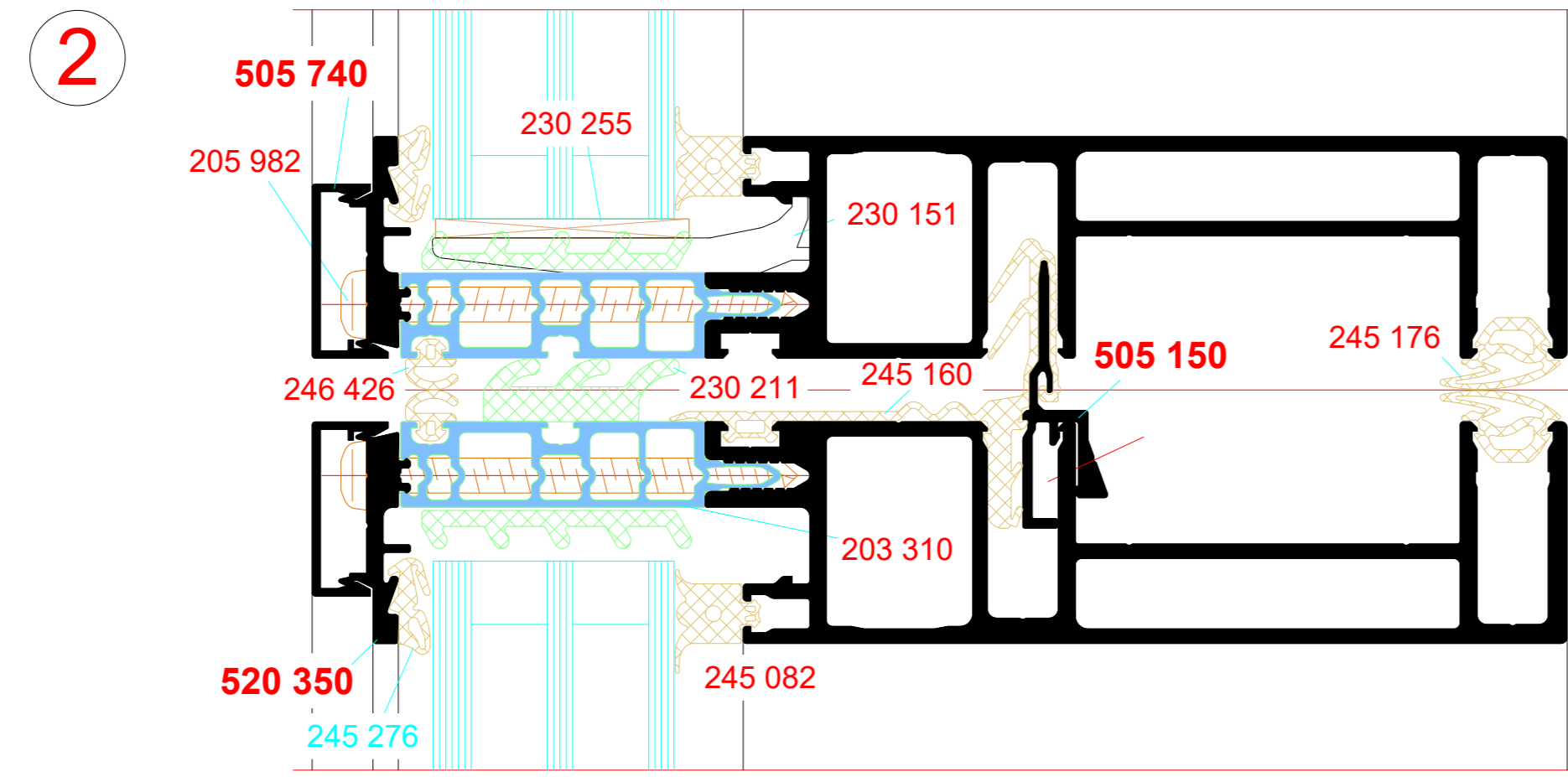
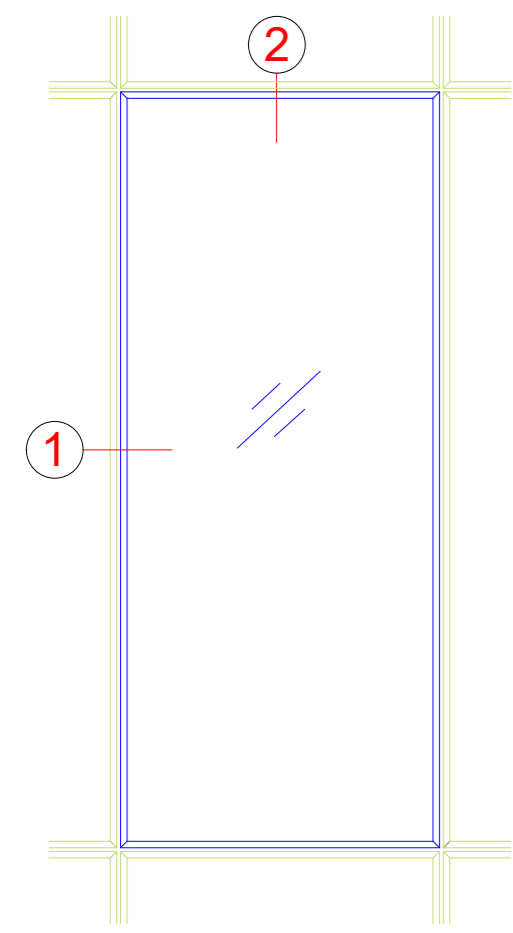

Rahmen, Bautiefe 130mm-180mm,
20mm Fugenmaß

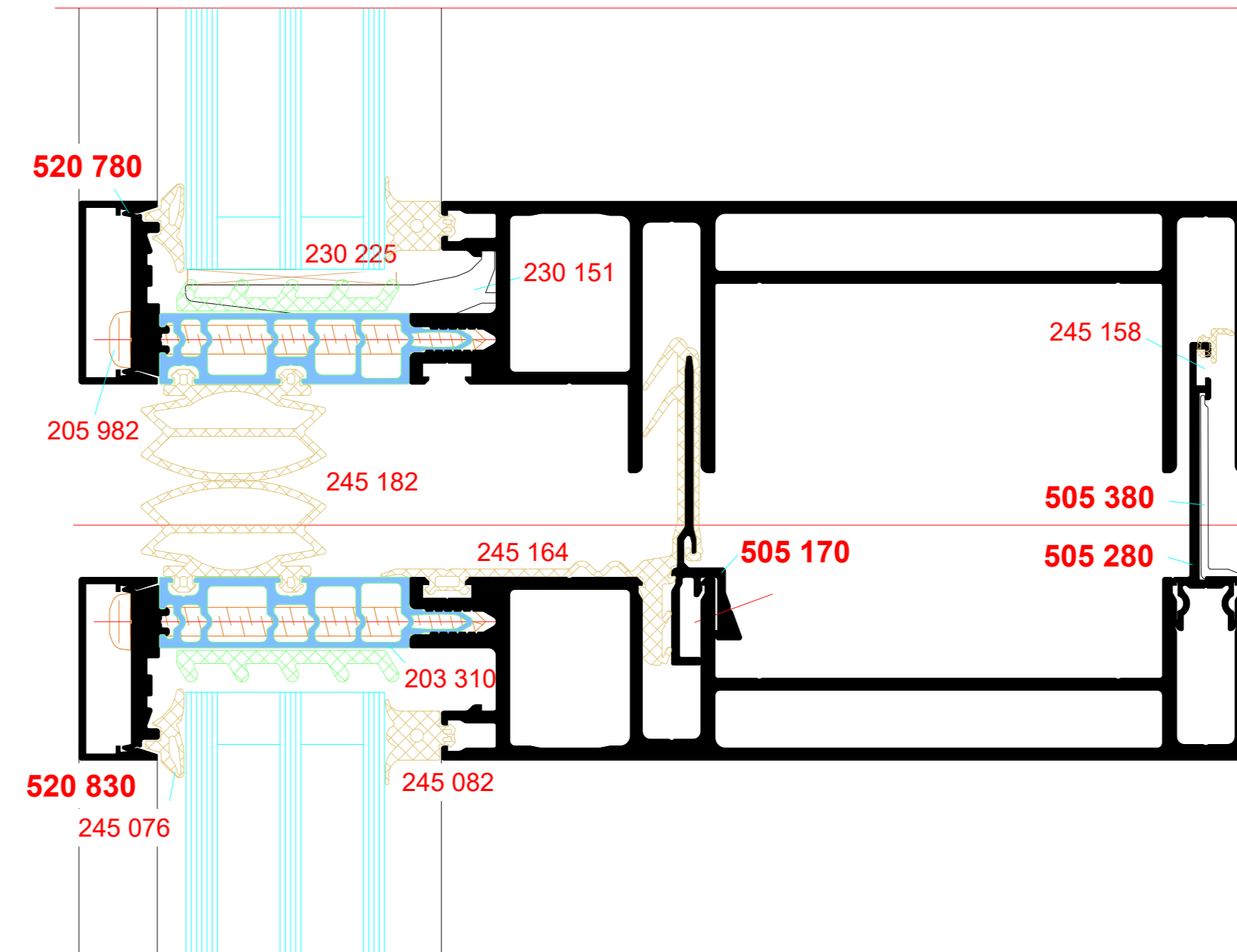

Rahmen, Bautiefe 130mm-180mm,
15mm Fugenmaß

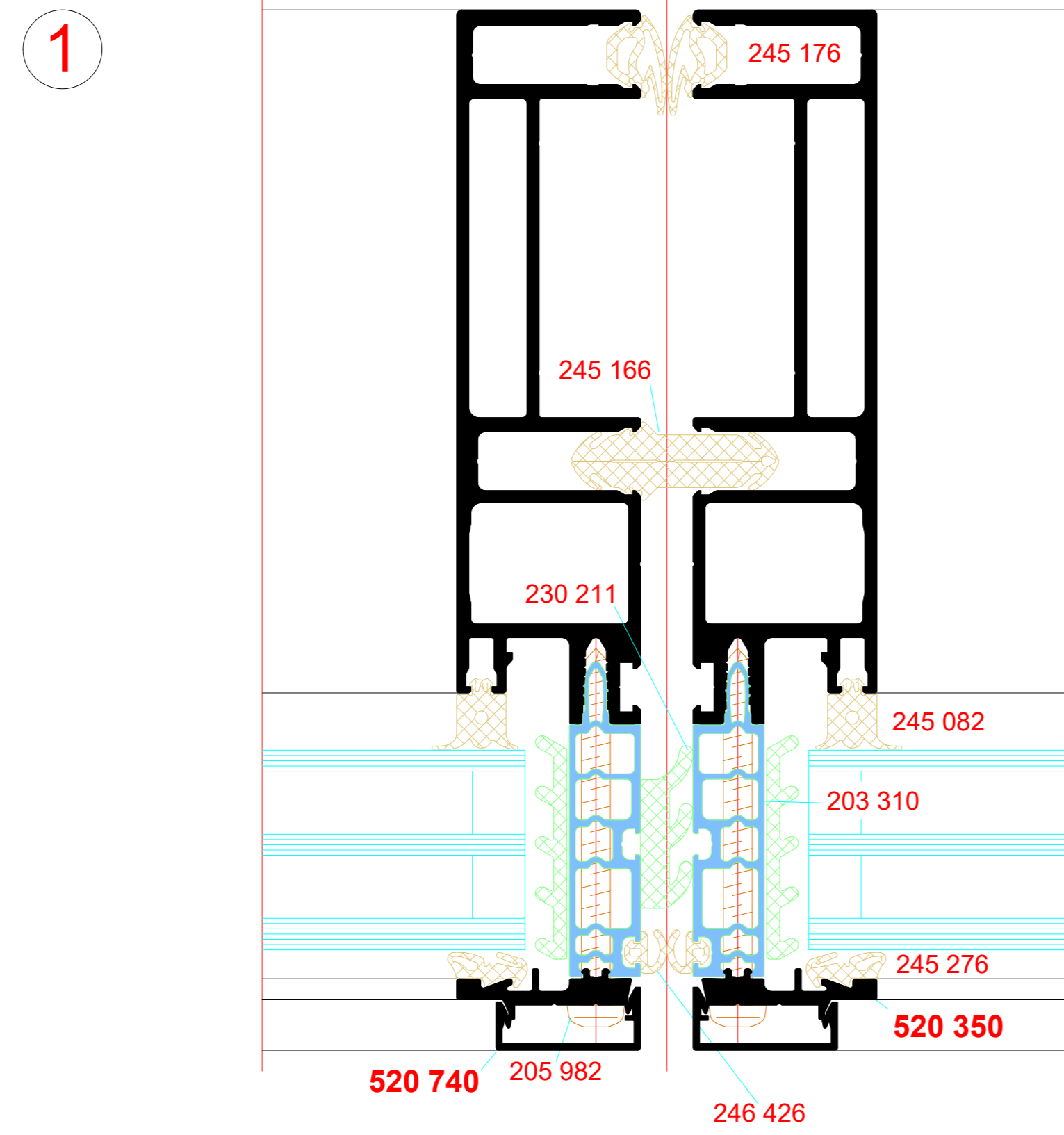

NO	DATE	DESCRIPTION	DESIGNED BY	CHECKED BY
001	2021	Initial	BRUNO	BRUNO
002	2021	Update	BRUNO	BRUNO
003	2021	Update	BRUNO	BRUNO
004	2021	Update	BRUNO	BRUNO
005	2021	Update	BRUNO	BRUNO
006	2021	Update	BRUNO	BRUNO
007	2021	Update	BRUNO	BRUNO
008	2021	Update	BRUNO	BRUNO
009	2021	Update	BRUNO	BRUNO
010	2021	Update	BRUNO	BRUNO
011	2021	Update	BRUNO	BRUNO
012	2021	Update	BRUNO	BRUNO
013	2021	Update	BRUNO	BRUNO
014	2021	Update	BRUNO	BRUNO
015	2021	Update	BRUNO	BRUNO
016	2021	Update	BRUNO	BRUNO
017	2021	Update	BRUNO	BRUNO
018	2021	Update	BRUNO	BRUNO
019	2021	Update	BRUNO	BRUNO
020	2021	Update	BRUNO	BRUNO
021	2021	Update	BRUNO	BRUNO
022	2021	Update	BRUNO	BRUNO
023	2021	Update	BRUNO	BRUNO
024	2021	Update	BRUNO	BRUNO
025	2021	Update	BRUNO	BRUNO
026	2021	Update	BRUNO	BRUNO
027	2021	Update	BRUNO	BRUNO
028	2021	Update	BRUNO	BRUNO
029	2021	Update	BRUNO	BRUNO
030	2021	Update	BRUNO	BRUNO
031	2021	Update	BRUNO	BRUNO
032	2021	Update	BRUNO	BRUNO
033	2021	Update	BRUNO	BRUNO
034	2021	Update	BRUNO	BRUNO
035	2021	Update	BRUNO	BRUNO
036	2021	Update	BRUNO	BRUNO
037	2021	Update	BRUNO	BRUNO
038	2021	Update	BRUNO	BRUNO
039	2021	Update	BRUNO	BRUNO
040	2021	Update	BRUNO	BRUNO
041	2021	Update	BRUNO	BRUNO
042	2021	Update	BRUNO	BRUNO
043	2021	Update	BRUNO	BRUNO
044	2021	Update	BRUNO	BRUNO
045	2021	Update	BRUNO	BRUNO
046	2021	Update	BRUNO	BRUNO
047	2021	Update	BRUNO	BRUNO
048	2021	Update	BRUNO	BRUNO
049	2021	Update	BRUNO	BRUNO
050	2021	Update	BRUNO	BRUNO
051	2021	Update	BRUNO	BRUNO
052	2021	Update	BRUNO	BRUNO
053	2021	Update	BRUNO	BRUNO
054	2021	Update	BRUNO	BRUNO
055	2021	Update	BRUNO	BRUNO
056	2021	Update	BRUNO	BRUNO
057	2021	Update	BRUNO	BRUNO
058	2021	Update	BRUNO	BRUNO
059	2021	Update	BRUNO	BRUNO
060	2021	Update	BRUNO	BRUNO
061	2021	Update	BRUNO	BRUNO
062	2021	Update	BRUNO	BRUNO
063	2021	Update	BRUNO	BRUNO
064	2021	Update	BRUNO	BRUNO
065	2021	Update	BRUNO	BRUNO
066	2021	Update	BRUNO	BRUNO
067	2021	Update	BRUNO	BRUNO
068	2021	Update	BRUNO	BRUNO
069	2021	Update	BRUNO	BRUNO
070	2021	Update	BRUNO	BRUNO
071	2021	Update	BRUNO	BRUNO
072	2021	Update	BRUNO	BRUNO
073	2021	Update	BRUNO	BRUNO
074	2021	Update	BRUNO	BRUNO
075	2021	Update	BRUNO	BRUNO
076	2021	Update	BRUNO	BRUNO
077	2021	Update	BRUNO	BRUNO
078	2021	Update	BRUNO	BRUNO
079	2021	Update	BRUNO	BRUNO
080	2021	Update	BRUNO	BRUNO
081	2021	Update	BRUNO	BRUNO
082	2021	Update	BRUNO	BRUNO
083	2021	Update	BRUNO	BRUNO
084	2021	Update	BRUNO	BRUNO
085	2021	Update	BRUNO	BRUNO
086	2021	Update	BRUNO	BRUNO
087	2021	Update	BRUNO	BRUNO
088	2021	Update	BRUNO	BRUNO
089	2021	Update	BRUNO	BRUNO
090	2021	Update	BRUNO	BRUNO
091	2021	Update	BRUNO	BRUNO
092	2021	Update	BRUNO	BRUNO
093	2021	Update	BRUNO	BRUNO
094	2021	Update	BRUNO	BRUNO
095	2021	Update	BRUNO	BRUNO
096	2021	Update	BRUNO	BRUNO
097	2021	Update	BRUNO	BRUNO
098	2021	Update	BRUNO	BRUNO
099	2021	Update	BRUNO	BRUNO
100	2021	Update	BRUNO	BRUNO

Sprosse, 80 mm Ansichtsbreite

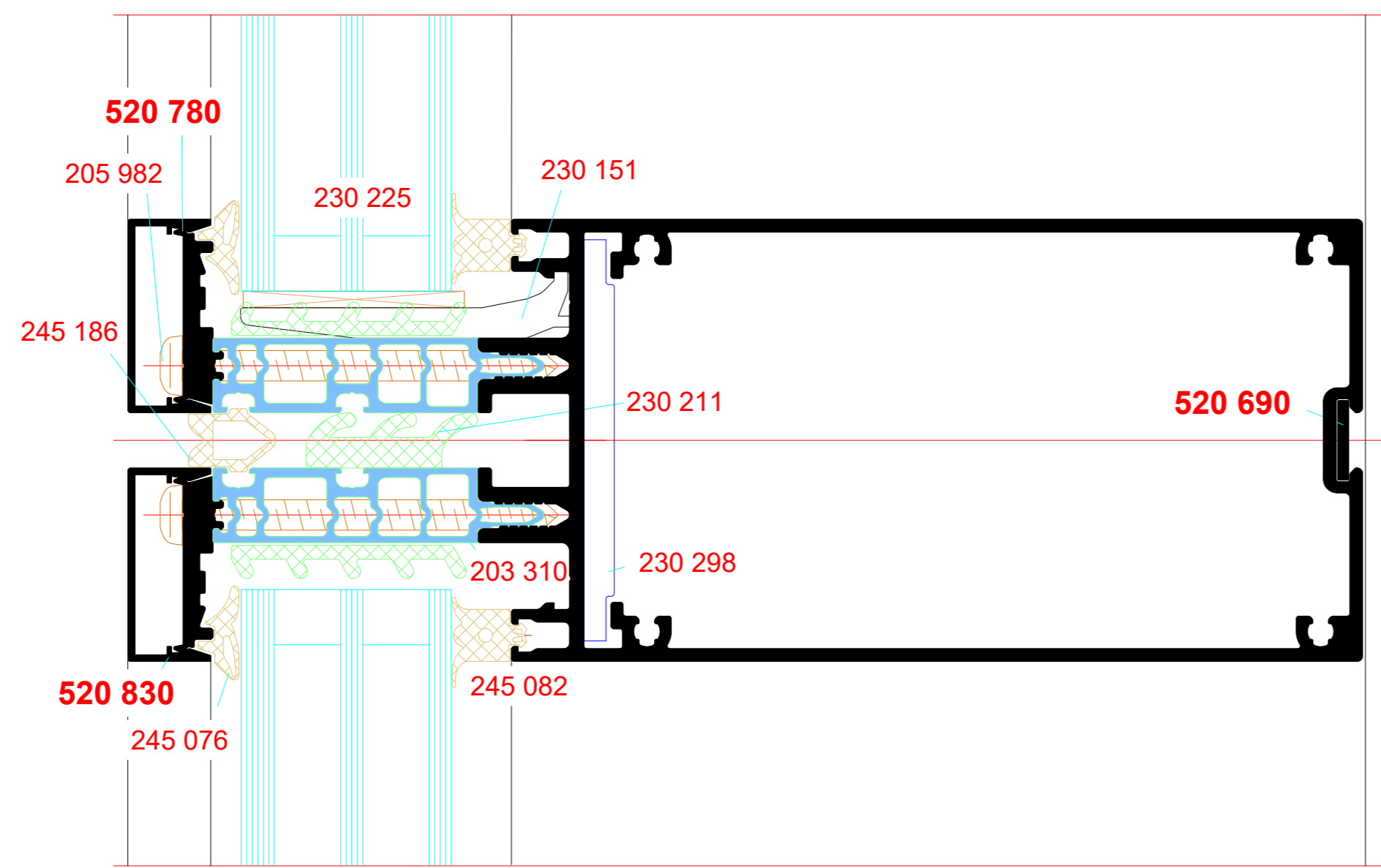
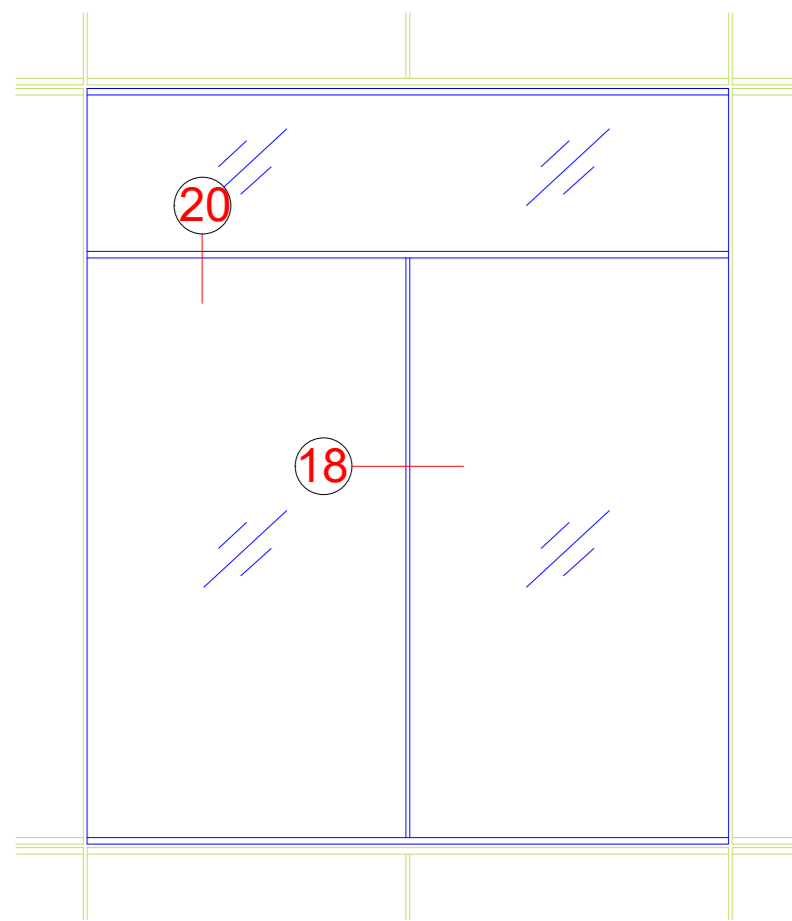

Sprosse, 60 mm Ansichtsbreite

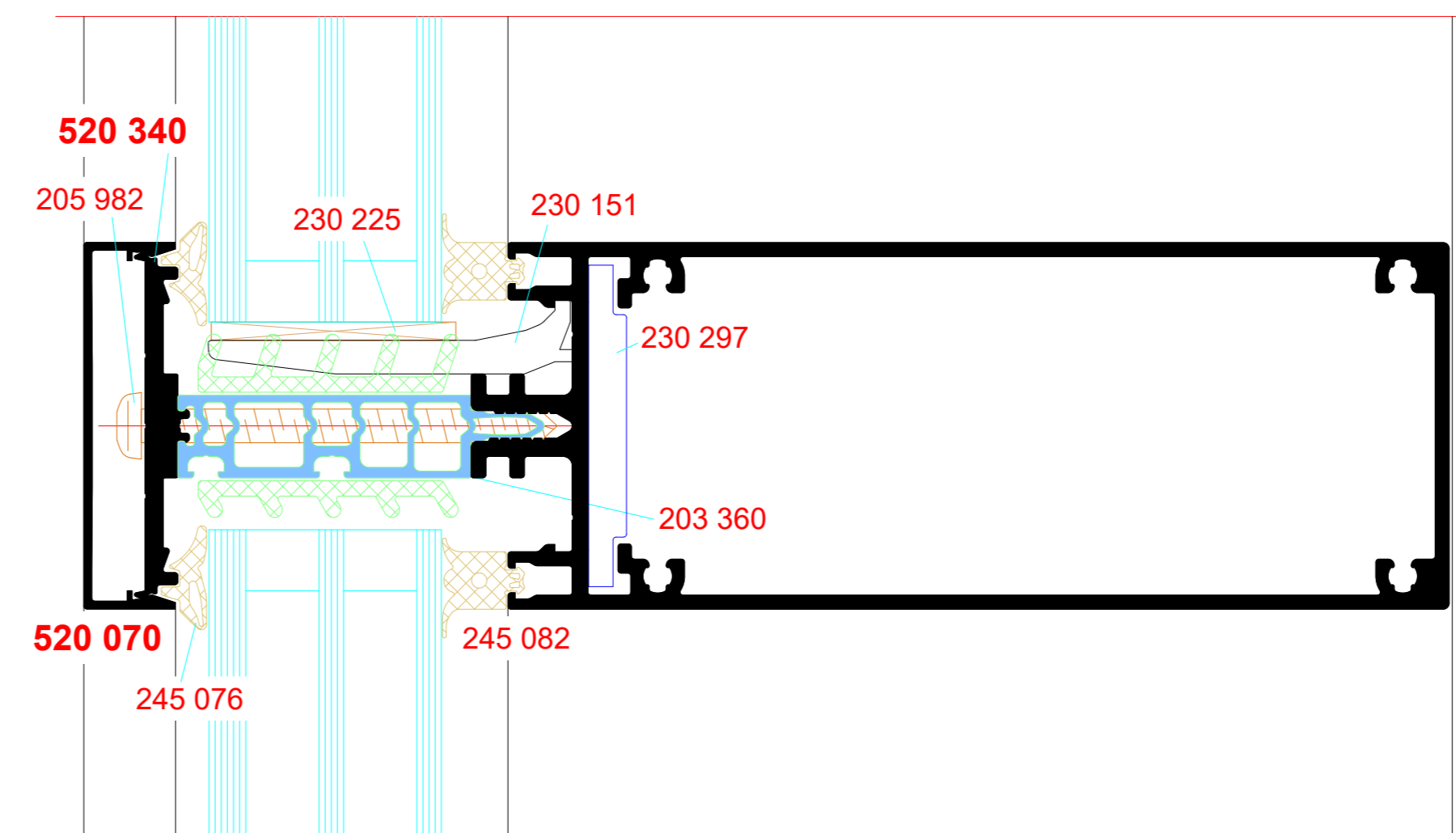

Sprosse, 80 mm Ansichtsbreite

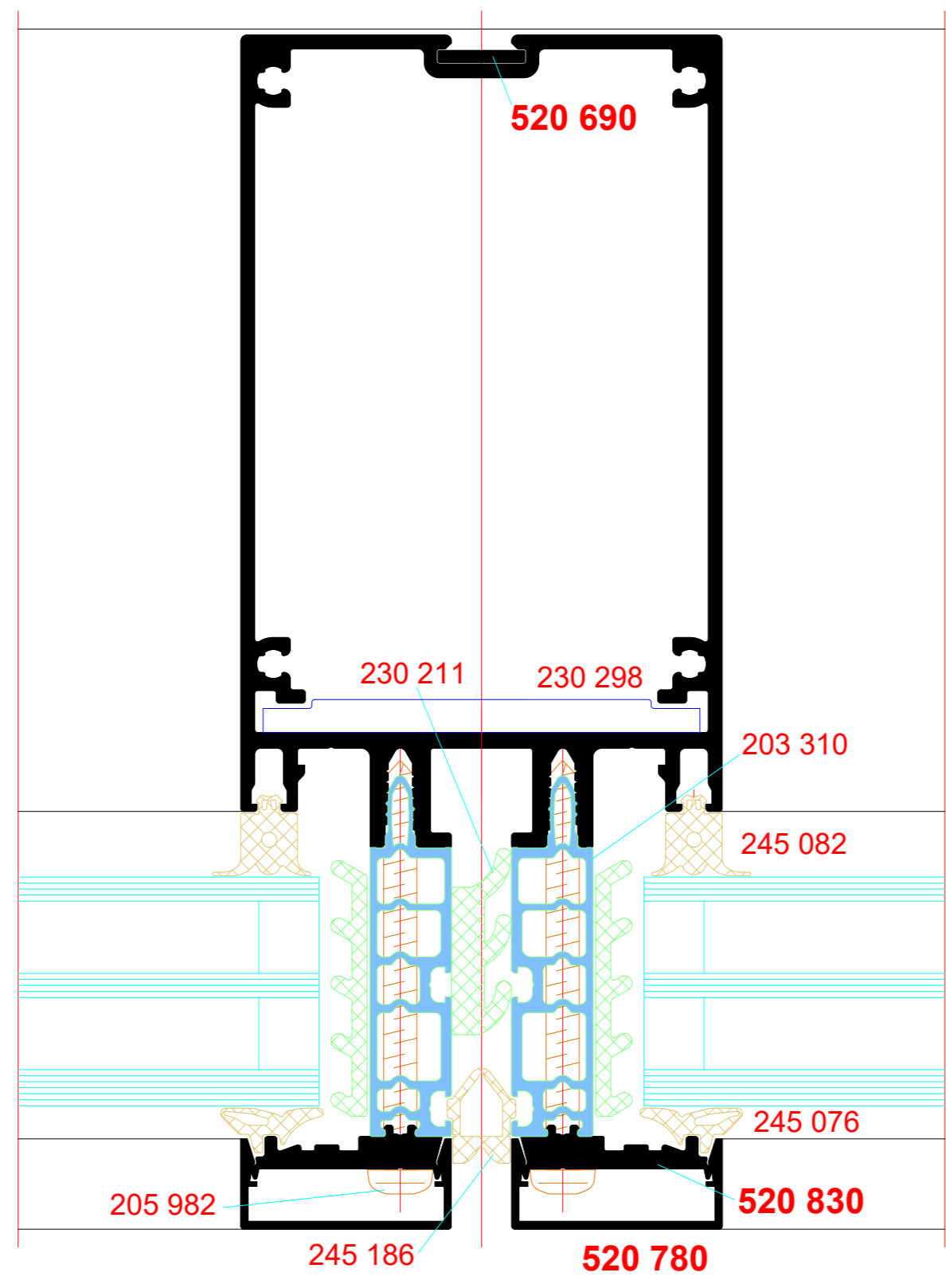

Sprosse, 60 mm Ansichtsbreite

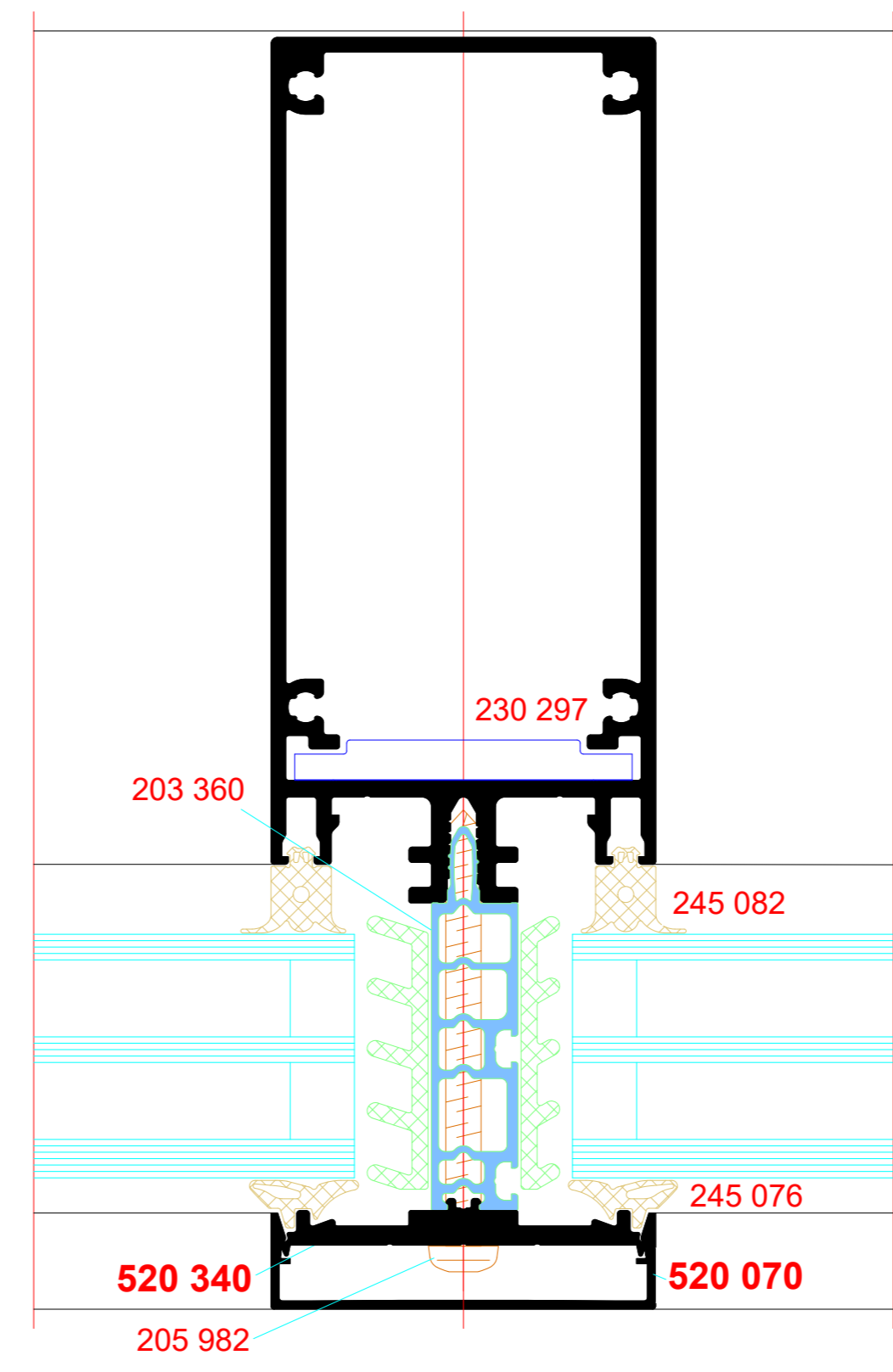

NO	DATE	REVISION	DESIGNED BY	DRAWN BY
001	2021	01	BENEDICT + RIVA	BENEDICT + RIVA
PROJECT: RIVA Elementschritte RIVA Unit section details				
PROJECT: Facade RIVA AF UDC 80 Facade RIVA AF UDC 80				
DESIGNED BY: BENEDICT + RIVA DRAWN BY: BENEDICT + RIVA DATE: 2021-01-01 SCALE: 1:10				

Kaltbrüstung
Sprosse, 60 mm Ansichtsbreite

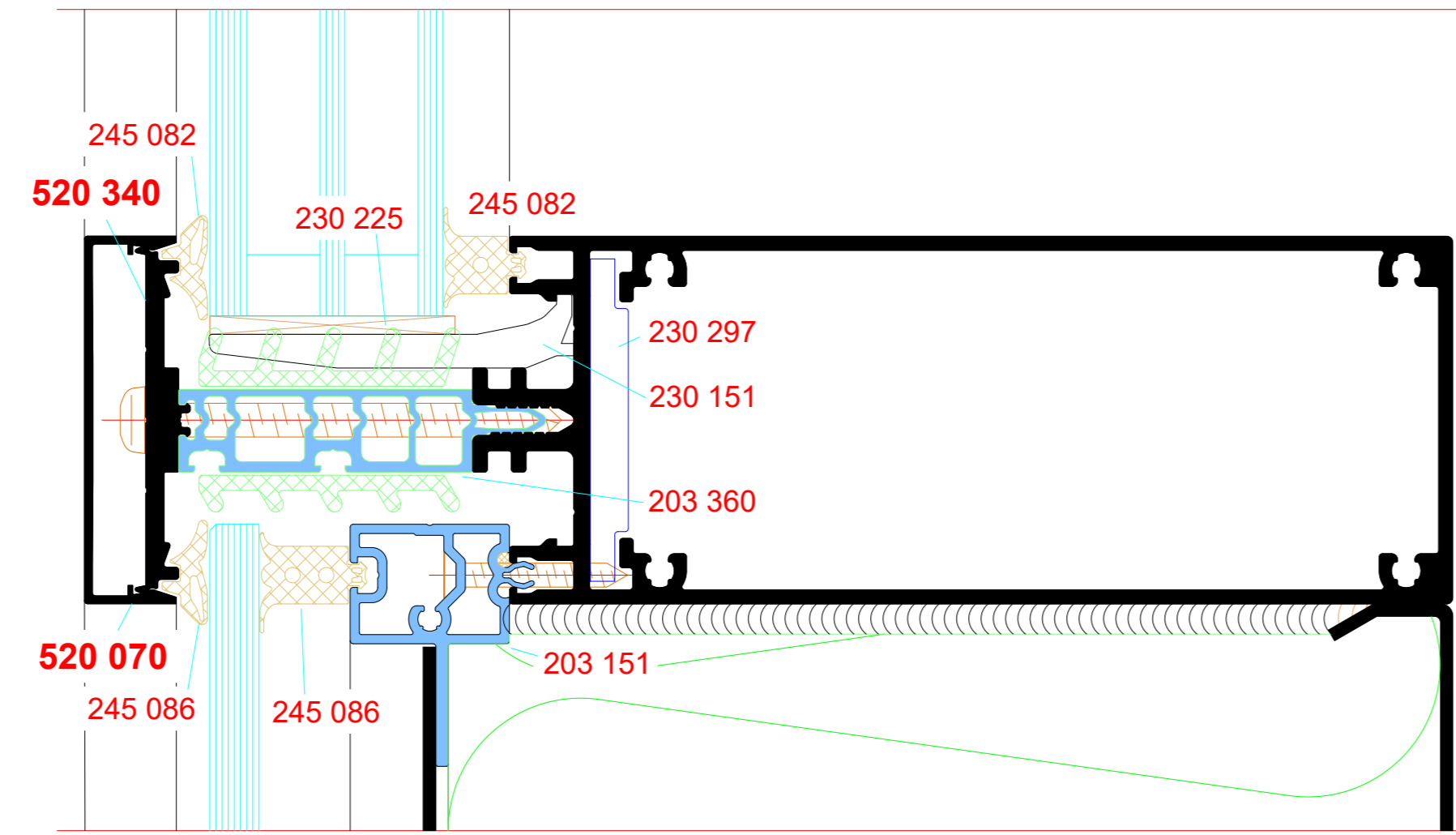
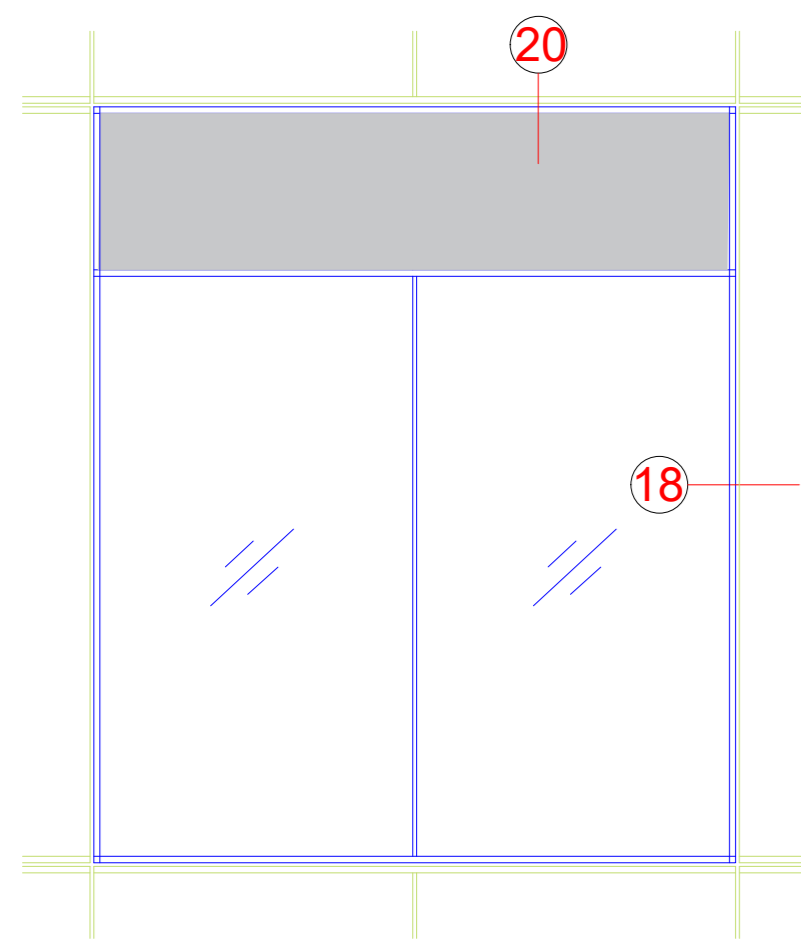

Kaltbrüstung
Sprosse, 80 mm Ansichtsbreite

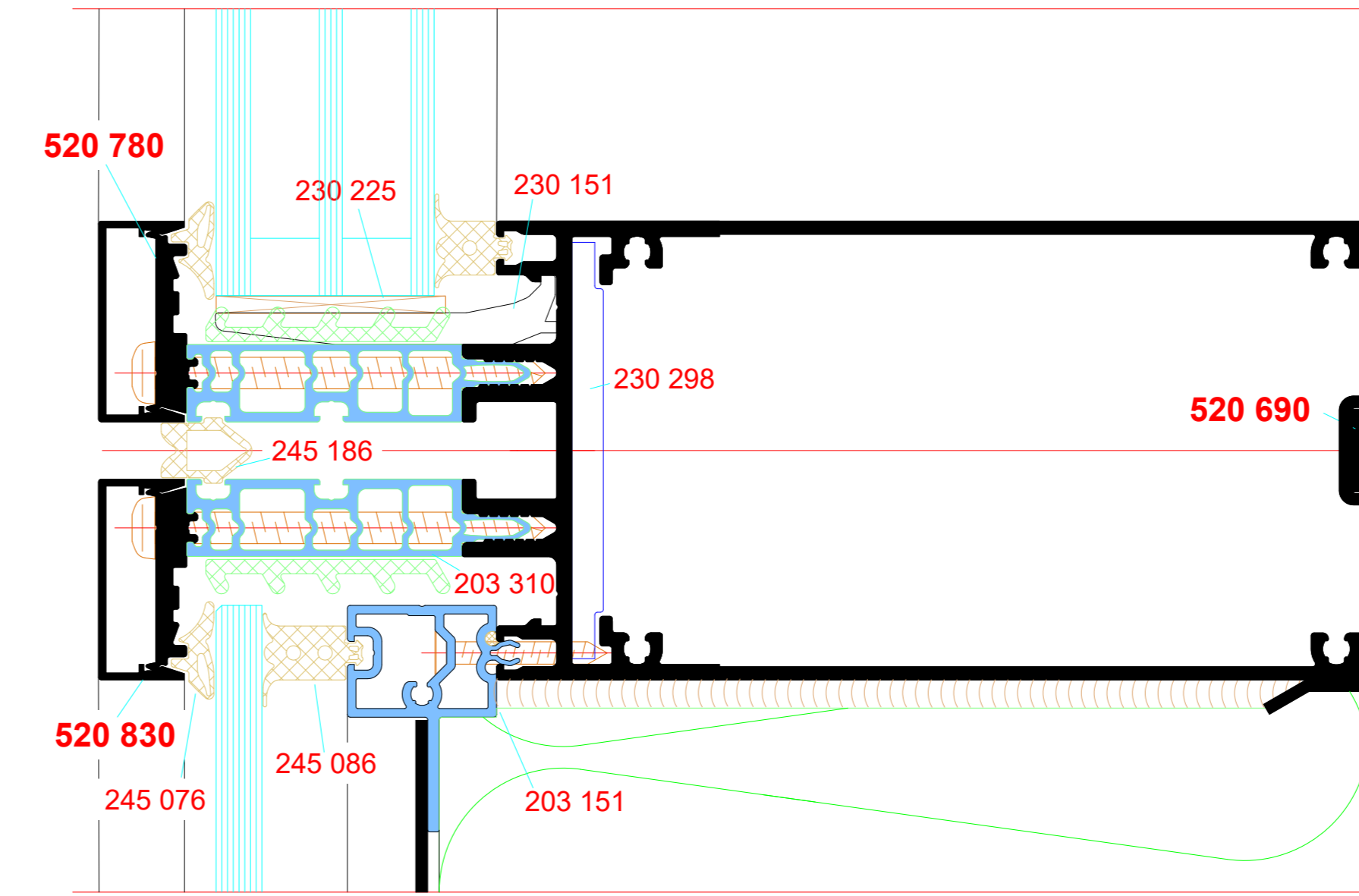

Kaltbrüstung
Rahmen, 10 mm Fugenmaß

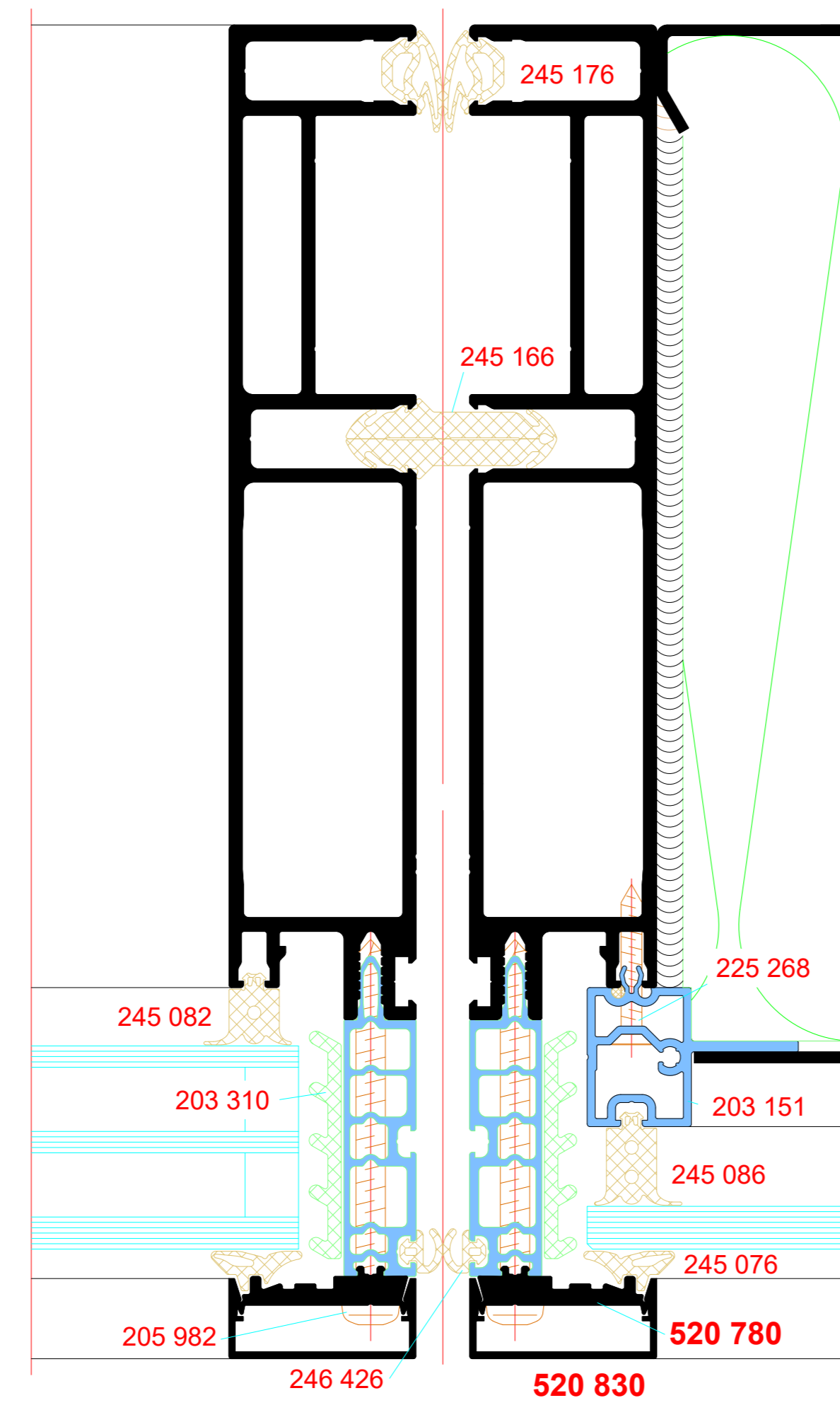

opake Fläche, flächenbündig
Rahmen, 10 mm Fugenmaß

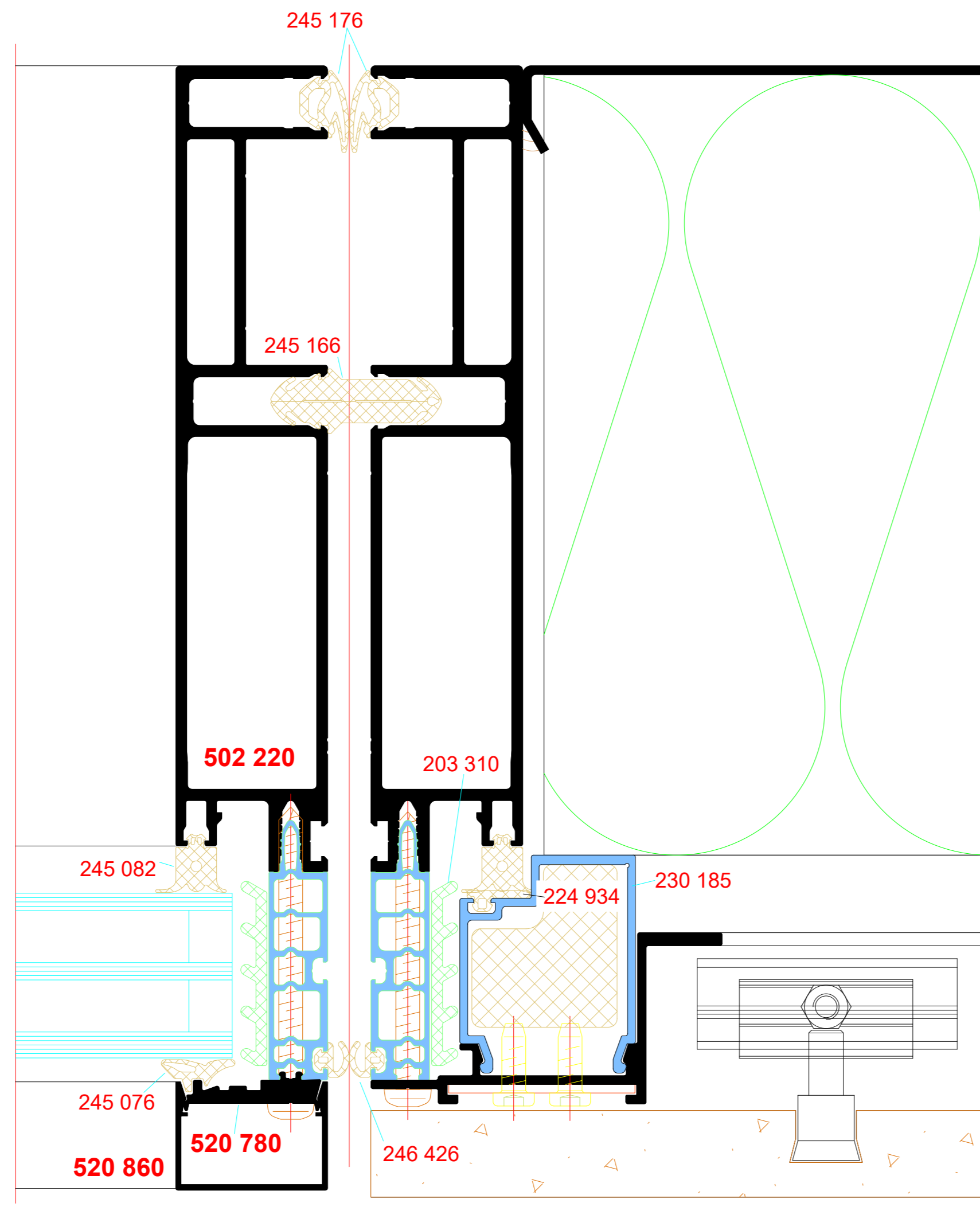
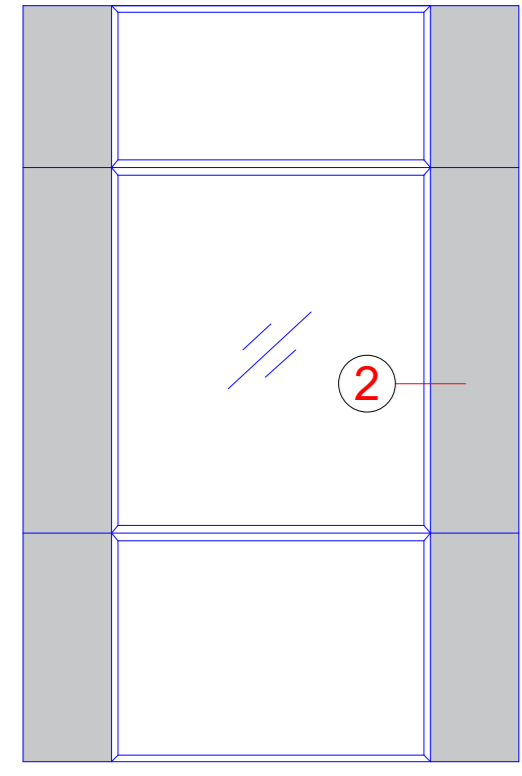

opake Fläche, flächenbündig
Rahmen, 10 mm Fugenmaß

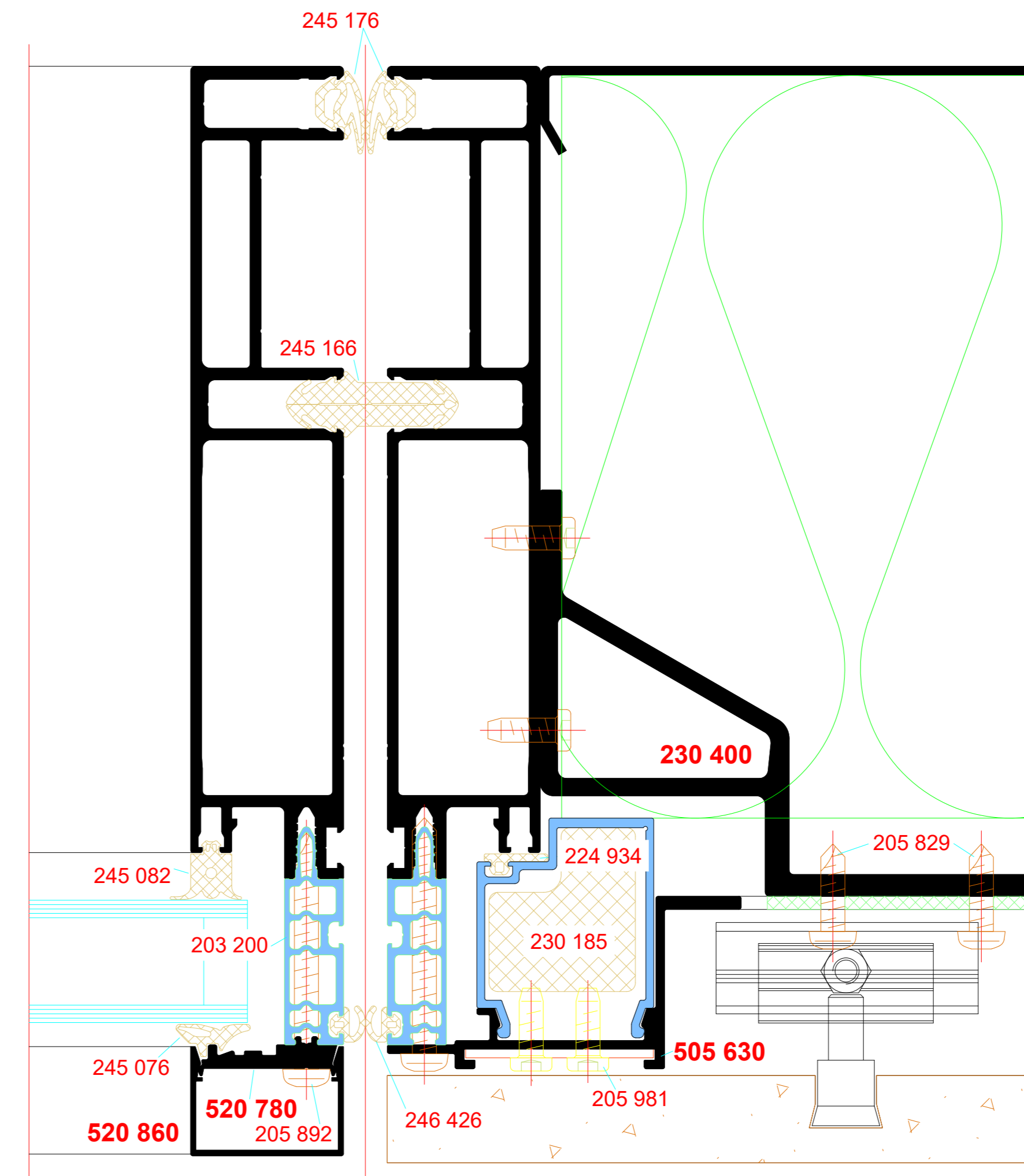

NO.	DATE	REVISION	REVISION	REVISION
1	2023	1	1	1
BENEDICT + RIVA RIVA Elementschelle Riva UDC section details Facade RIVA AF UDC 80 Facade RIVA AF UDC 80				
BENEDICT + RIVA GmbH Industriestraße 11 42699 Solingen, Germany				

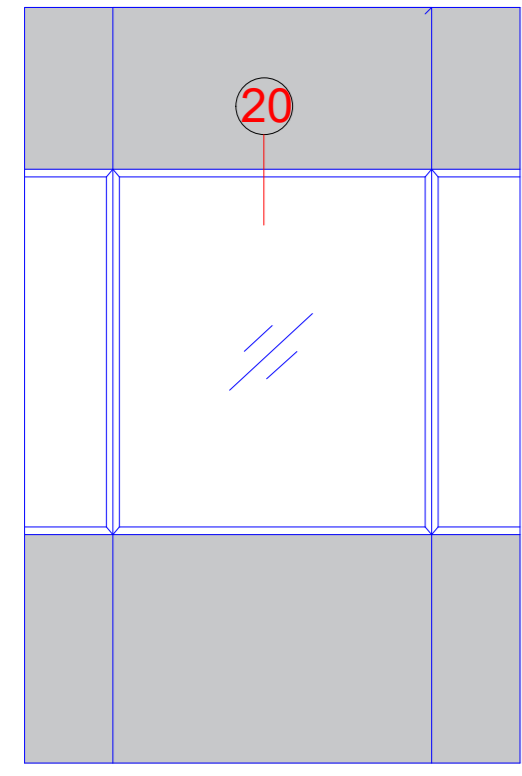

opake Fläche, flächenbündig
Rahmen, 10 mm Fugenmaß

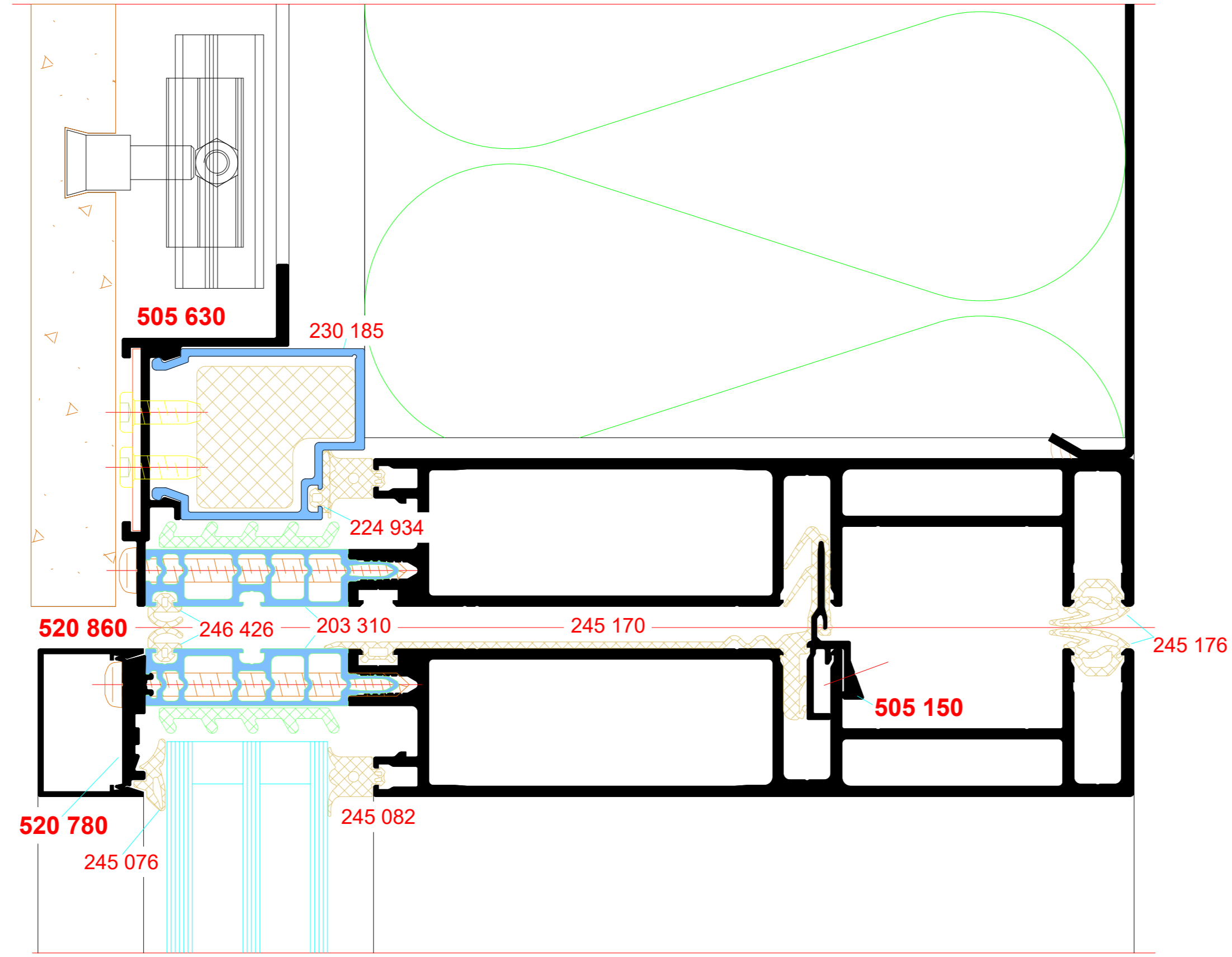

opake Fläche, flächenbündig
Sprosse, 80 mm Ansichtsbreite

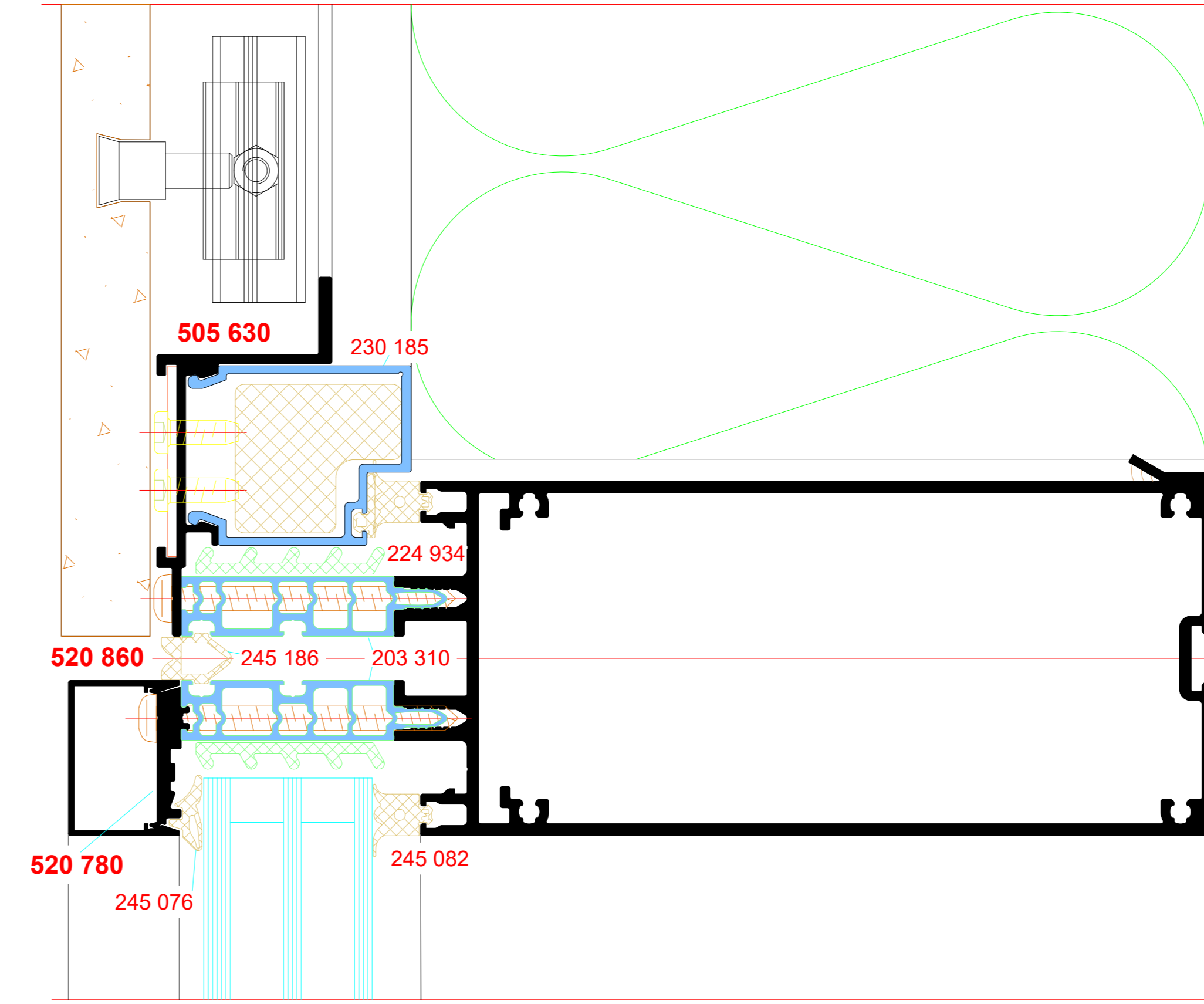

opake Fläche, flächenbündig
Rahmen, 10 mm Fugenmaß

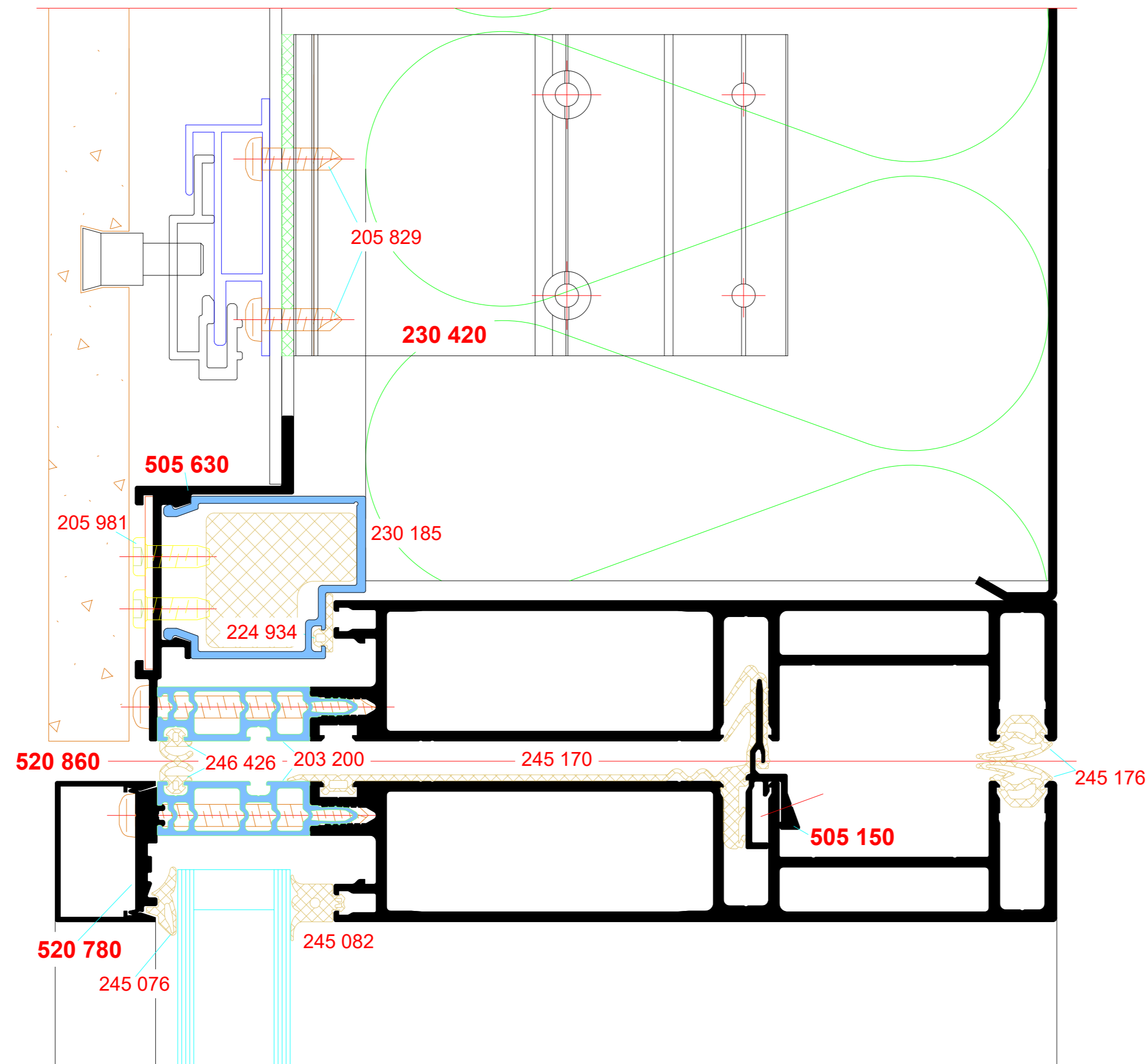

opake Fläche, flächenbündig
Sprosse, 80 mm Ansichtsbreite

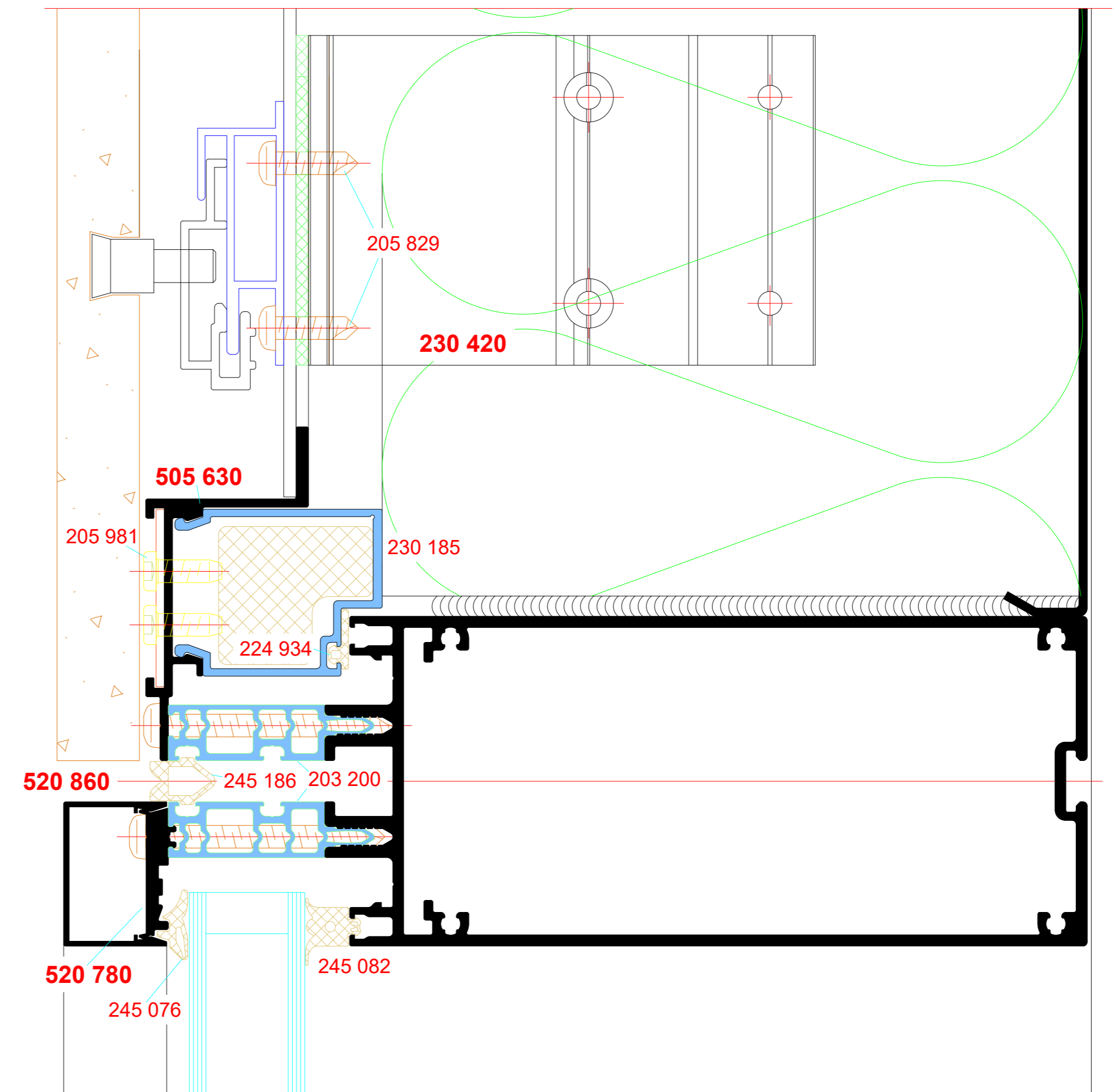

NO	DATE	VERSION	REVISION	STATUS
001	01.10.2023	01		Entwurf
002	02.10.2023	02		Prüfung
003	03.10.2023	03		Freigegeben
004	04.10.2023	04		Änderung
005	05.10.2023	05		Änderung
006	06.10.2023	06		Änderung
007	07.10.2023	07		Änderung
008	08.10.2023	08		Änderung
009	09.10.2023	09		Änderung
010	10.10.2023	10		Änderung
011	11.10.2023	11		Änderung
012	12.10.2023	12		Änderung
013	13.10.2023	13		Änderung
014	14.10.2023	14		Änderung
015	15.10.2023	15		Änderung
016	16.10.2023	16		Änderung
017	17.10.2023	17		Änderung
018	18.10.2023	18		Änderung
019	19.10.2023	19		Änderung
020	20.10.2023	20		Änderung
021	21.10.2023	21		Änderung
022	22.10.2023	22		Änderung
023	23.10.2023	23		Änderung
024	24.10.2023	24		Änderung
025	25.10.2023	25		Änderung
026	26.10.2023	26		Änderung
027	27.10.2023	27		Änderung
028	28.10.2023	28		Änderung
029	29.10.2023	29		Änderung
030	30.10.2023	30		Änderung
031	31.10.2023	31		Änderung
032	01.11.2023	32		Änderung
033	02.11.2023	33		Änderung
034	03.11.2023	34		Änderung
035	04.11.2023	35		Änderung
036	05.11.2023	36		Änderung
037	06.11.2023	37		Änderung
038	07.11.2023	38		Änderung
039	08.11.2023	39		Änderung
040	09.11.2023	40		Änderung
041	10.11.2023	41		Änderung
042	11.11.2023	42		Änderung
043	12.11.2023	43		Änderung
044	13.11.2023	44		Änderung
045	14.11.2023	45		Änderung
046	15.11.2023	46		Änderung
047	16.11.2023	47		Änderung
048	17.11.2023	48		Änderung
049	18.11.2023	49		Änderung
050	19.11.2023	50		Änderung
051	20.11.2023	51		Änderung
052	21.11.2023	52		Änderung
053	22.11.2023	53		Änderung
054	23.11.2023	54		Änderung
055	24.11.2023	55		Änderung
056	25.11.2023	56		Änderung
057	26.11.2023	57		Änderung
058	27.11.2023	58		Änderung
059	28.11.2023	59		Änderung
060	29.11.2023	60		Änderung
061	30.11.2023	61		Änderung
062	01.12.2023	62		Änderung
063	02.12.2023	63		Änderung
064	03.12.2023	64		Änderung
065	04.12.2023	65		Änderung
066	05.12.2023	66		Änderung
067	06.12.2023	67		Änderung
068	07.12.2023	68		Änderung
069	08.12.2023	69		Änderung
070	09.12.2023	70		Änderung
071	10.12.2023	71		Änderung
072	11.12.2023	72		Änderung
073	12.12.2023	73		Änderung
074	13.12.2023	74		Änderung
075	14.12.2023	75		Änderung
076	15.12.2023	76		Änderung
077	16.12.2023	77		Änderung
078	17.12.2023	78		Änderung
079	18.12.2023	79		Änderung
080	19.12.2023	80		Änderung
081	20.12.2023	81		Änderung
082	21.12.2023	82		Änderung
083	22.12.2023	83		Änderung
084	23.12.2023	84		Änderung
085	24.12.2023	85		Änderung
086	25.12.2023	86		Änderung
087	26.12.2023	87		Änderung
088	27.12.2023	88		Änderung
089	28.12.2023	89		Änderung
090	29.12.2023	90		Änderung
091	30.12.2023	91		Änderung
092	31.12.2023	92		Änderung
093	01.01.2024	93		Änderung
094	02.01.2024	94		Änderung
095	03.01.2024	95		Änderung
096	04.01.2024	96		Änderung
097	05.01.2024	97		Änderung
098	06.01.2024	98		Änderung
099	07.01.2024	99		Änderung
100	08.01.2024	100		Änderung

Rahmen, Bautiefe 180mm-255mm,
10mm Fugenmaß

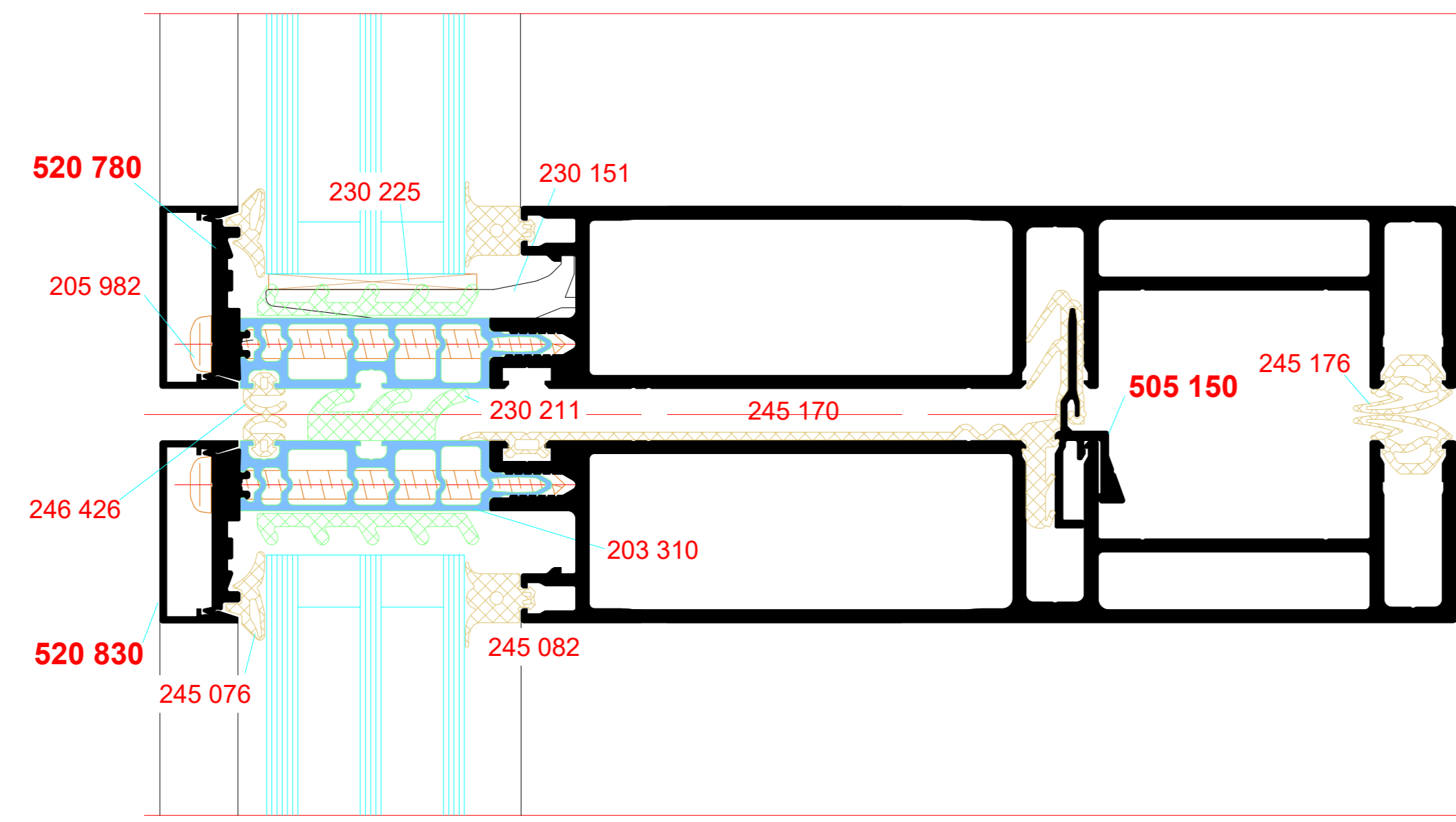
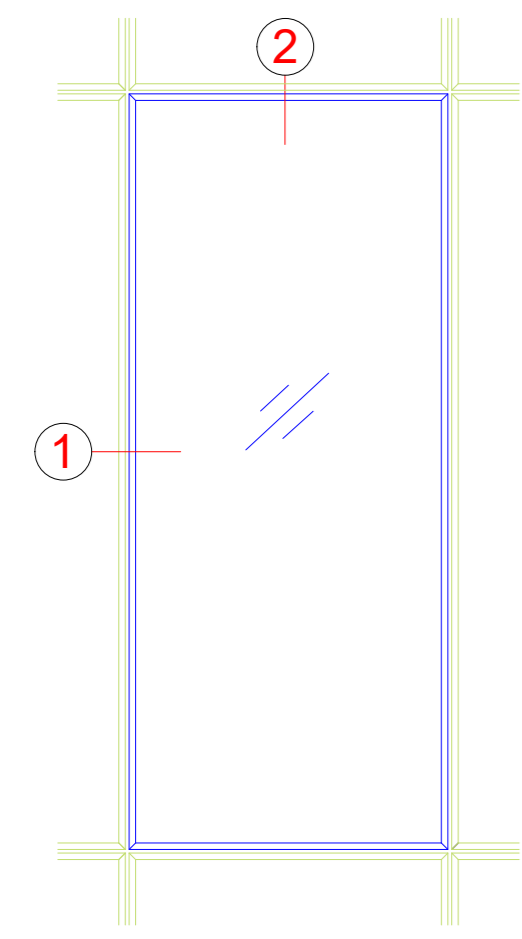

Rahmen, Bautiefe 180mm-255mm,
15mm Fugenmaß

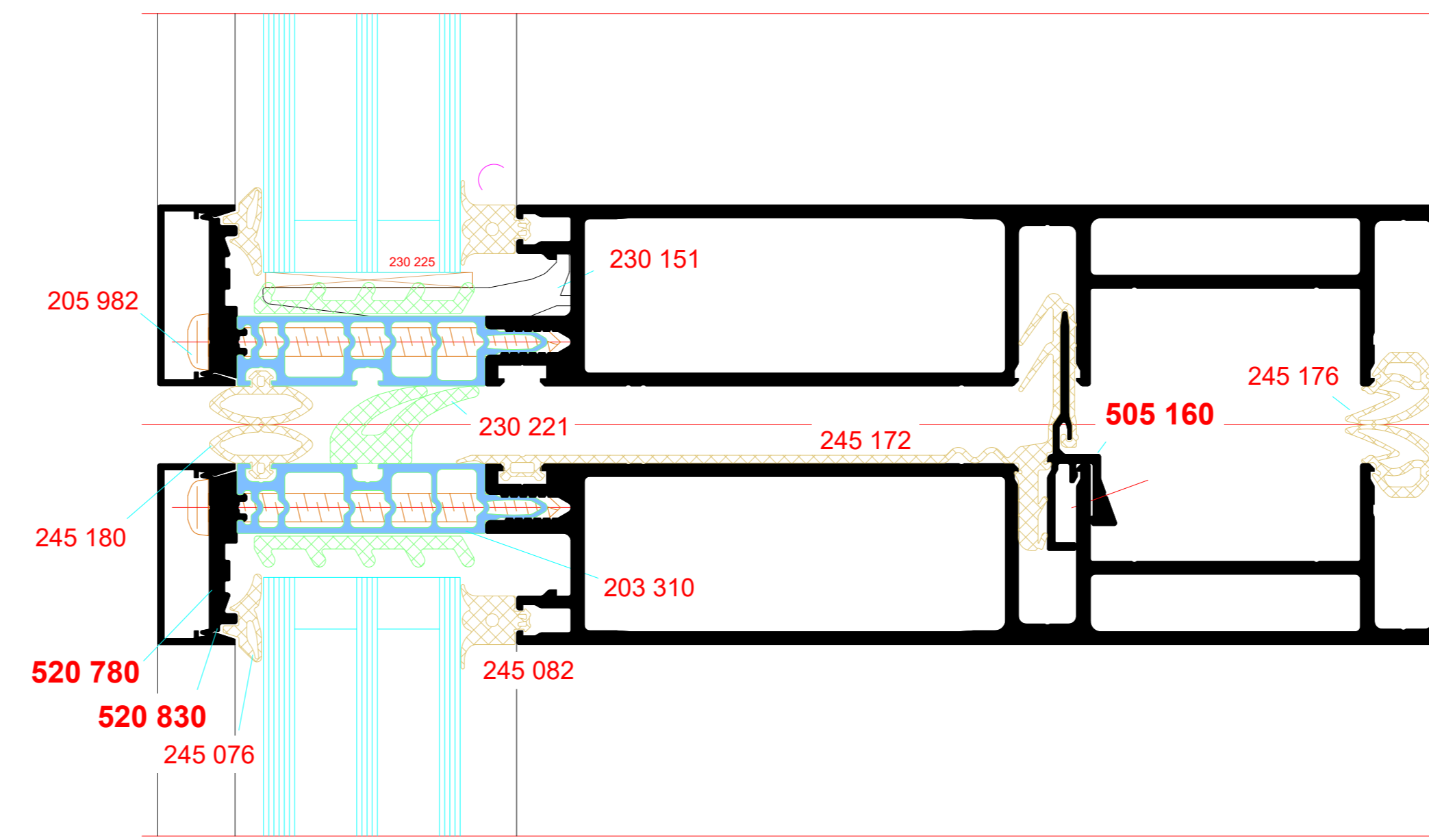

Rahmen, Bautiefe 180mm-255mm,
20mm Fugenmaß

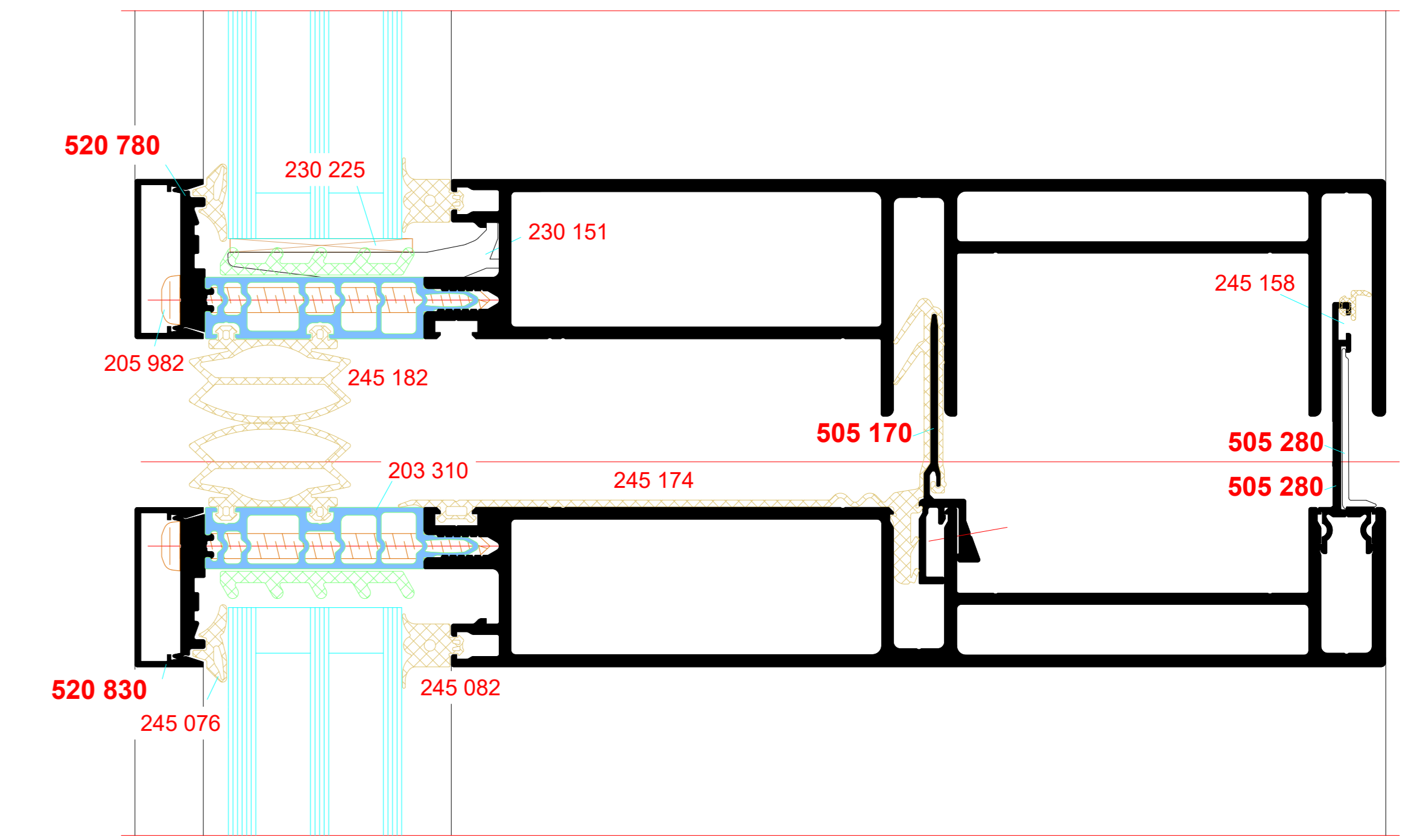

Rahmen, Bautiefe 180mm-255mm,
10mm Fugenmaß

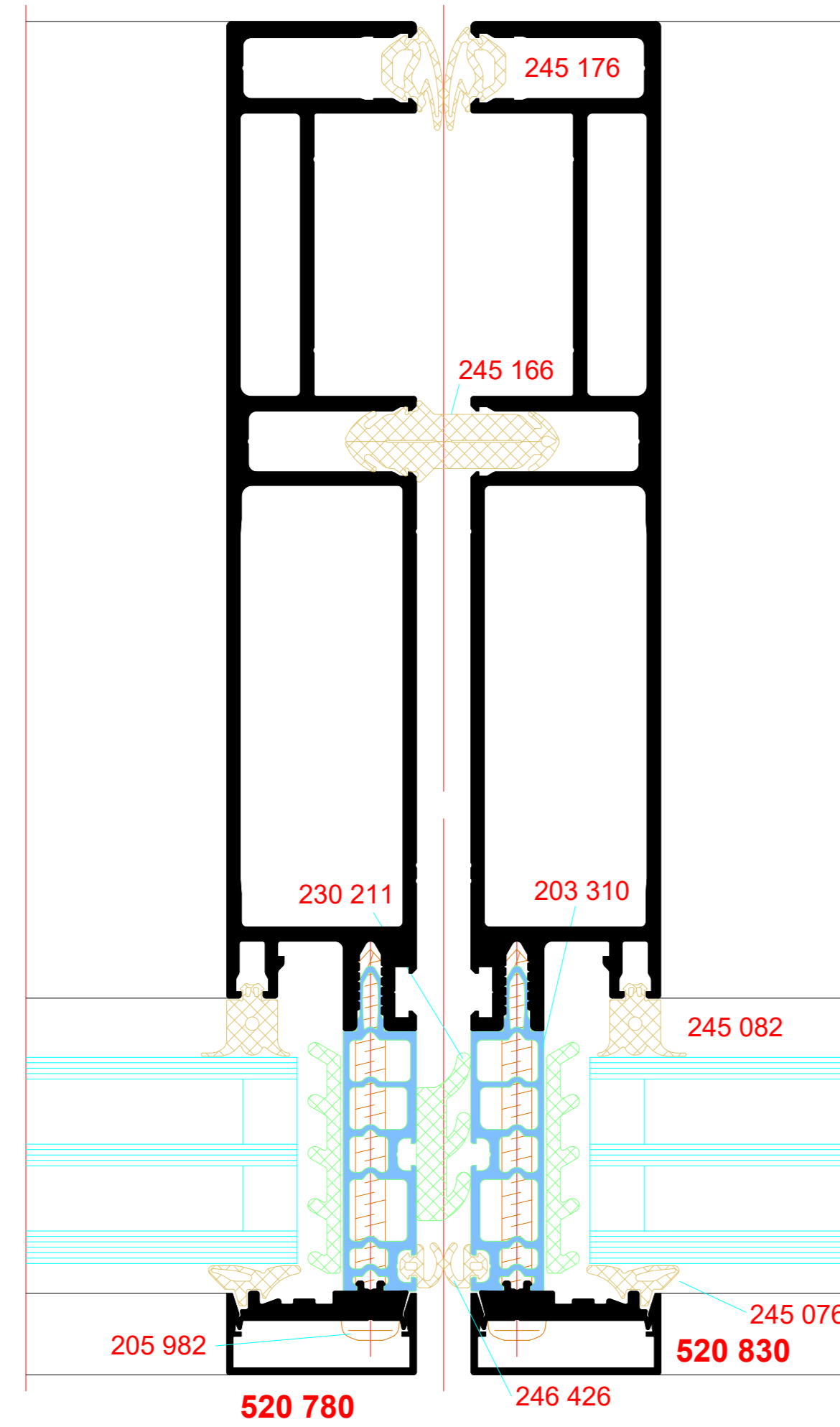

Rahmen, Bautiefe 180mm-255mm,
15mm Fugenmaß

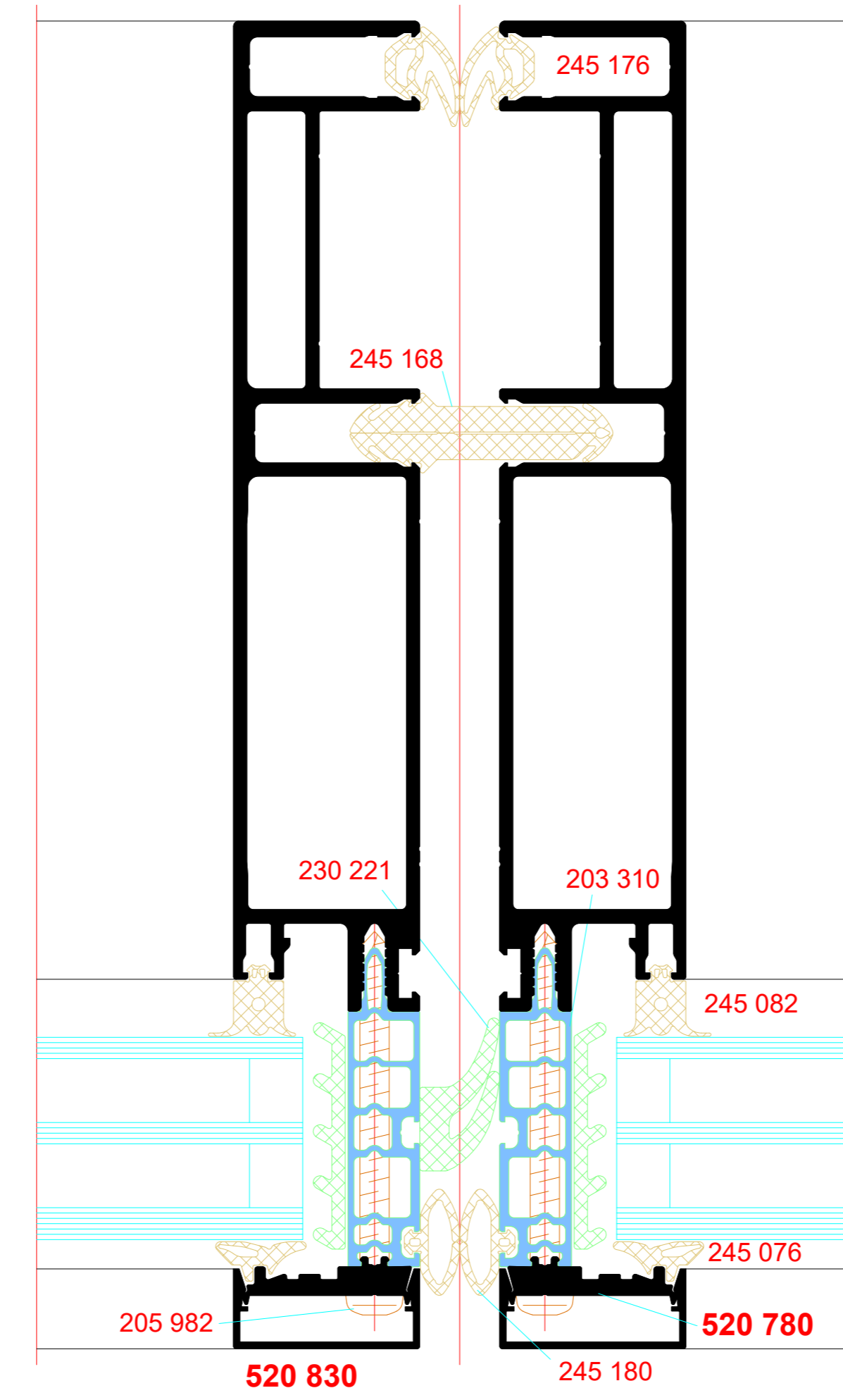

NO.	DATE	STATUS	REVISION	DESCRIPTION
001	01.12.2023	INITIAL		Release of the Riva Element Catalogue
002	01.12.2023	INITIAL		Release of the Riva Element Catalogue
003	01.12.2023	INITIAL		Release of the Riva Element Catalogue

PROJECT	Fassade RIVA AF UDC 80		
CLIENT	Fassade RIVA AF UDC 80		
ARCHITECT	BENEDICT + RIVA GmbH		
DESIGNER	BENEDICT + RIVA GmbH		
MANUFACTURER	BENEDICT + RIVA GmbH		
INSTALLATION	BENEDICT + RIVA GmbH		
DATE	01.12.2023	VERSION	001
SCALE	1:100	DRAWING NO.	RIVA_001

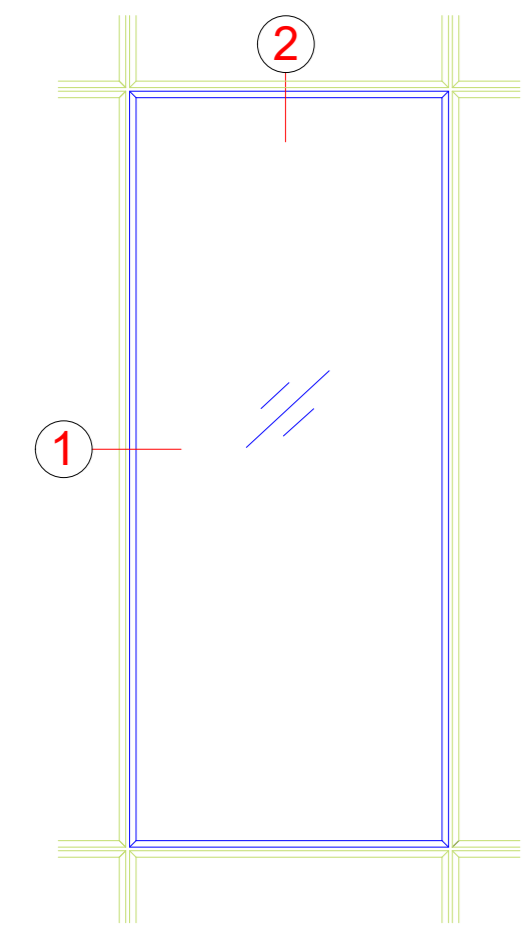

Rahmen, 10 mm Fugenmaß

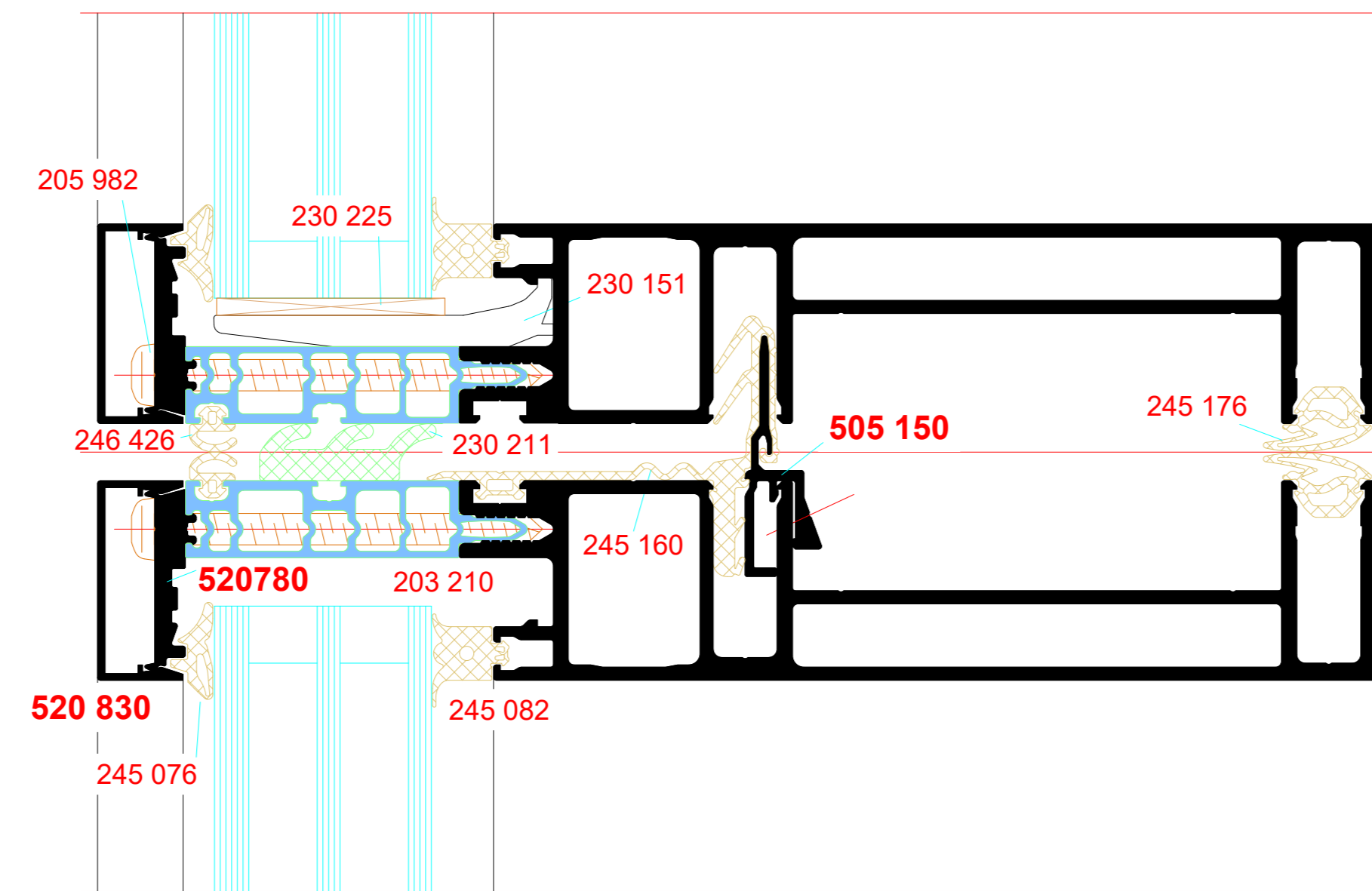

Rahmen, 10 mm Fugenmaß

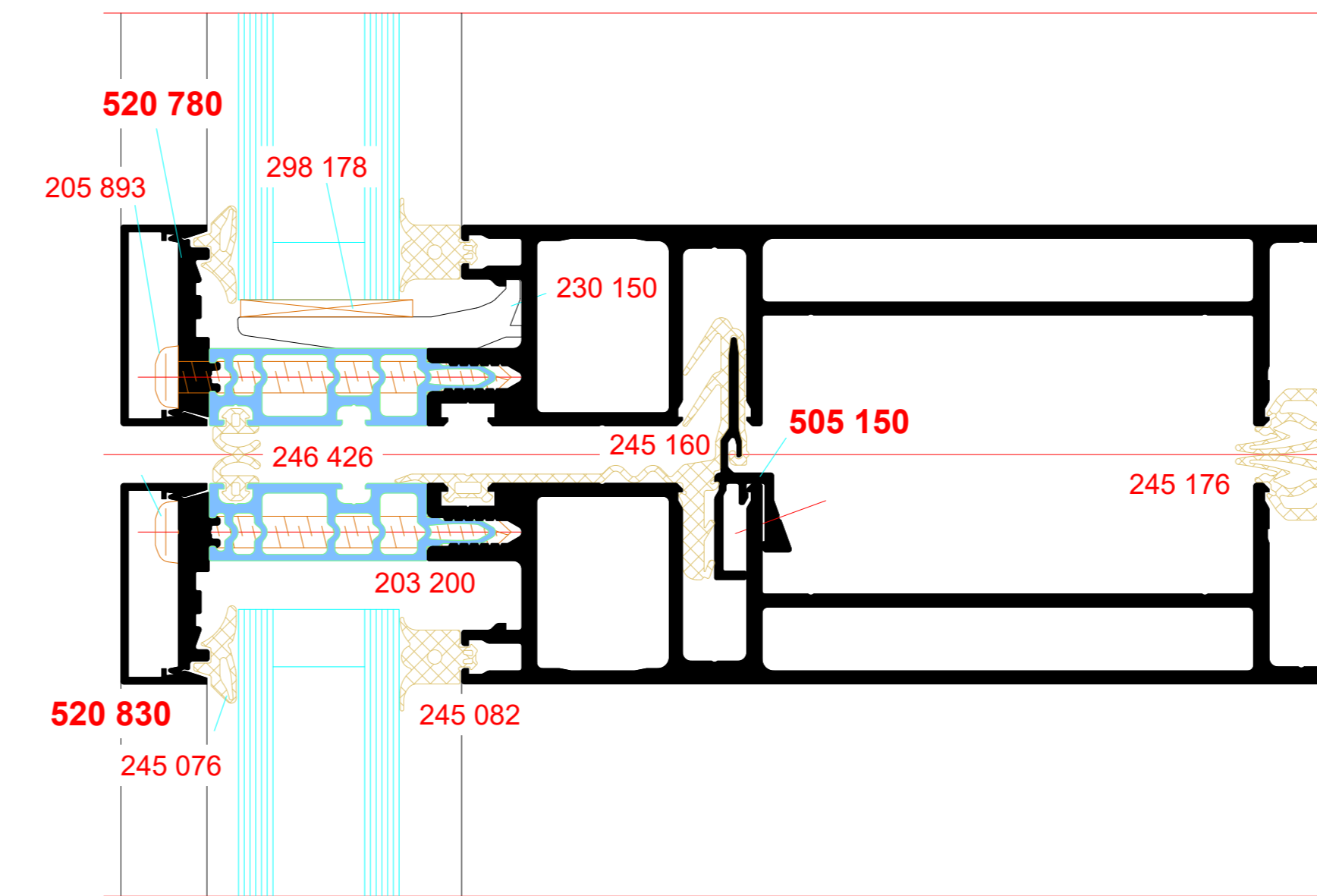

Rahmen, 10 mm Fugenmaß

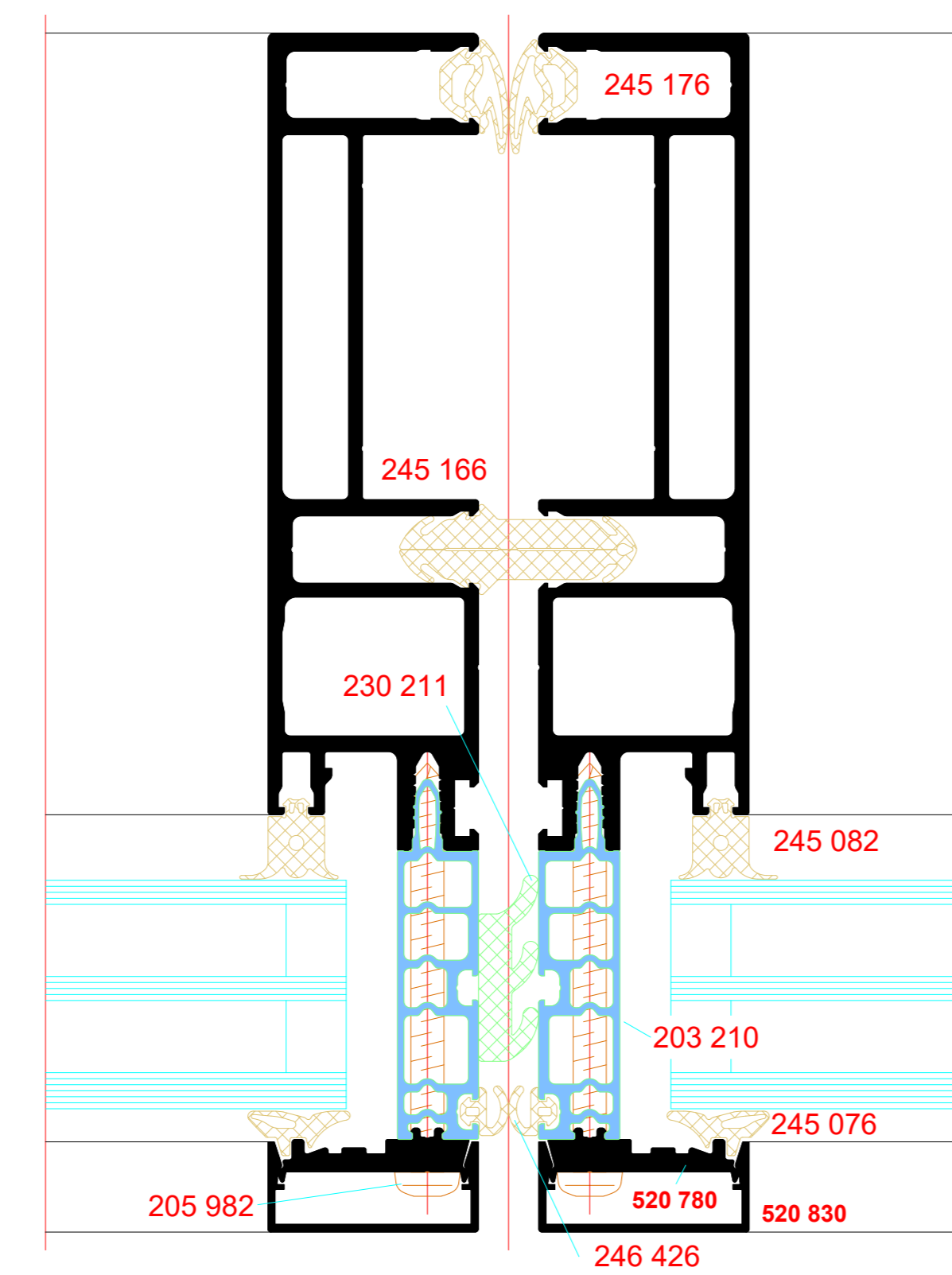

Rahmen, 10 mm Fugenmaß

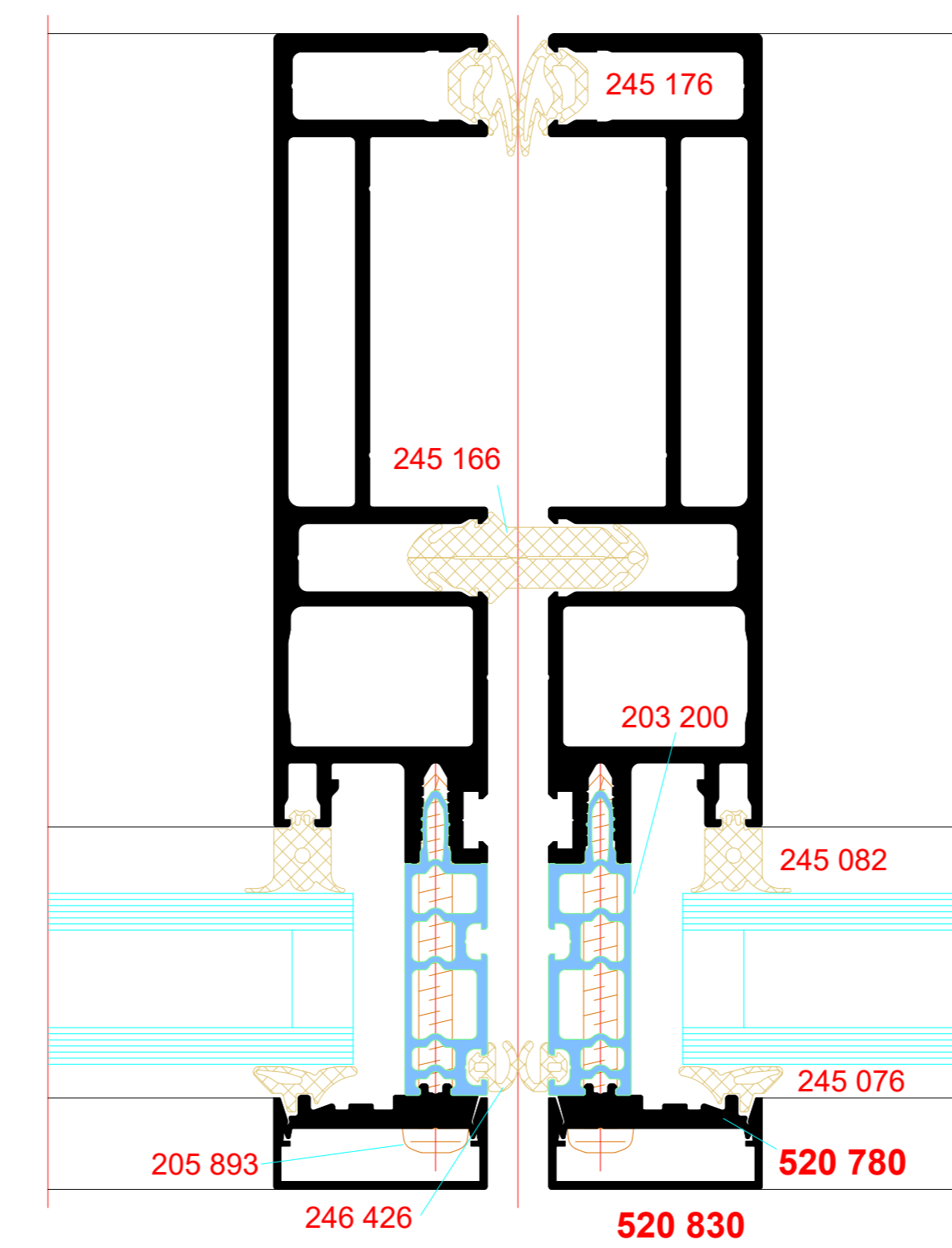

Sprosse, 80 mm Ansichtsbreite

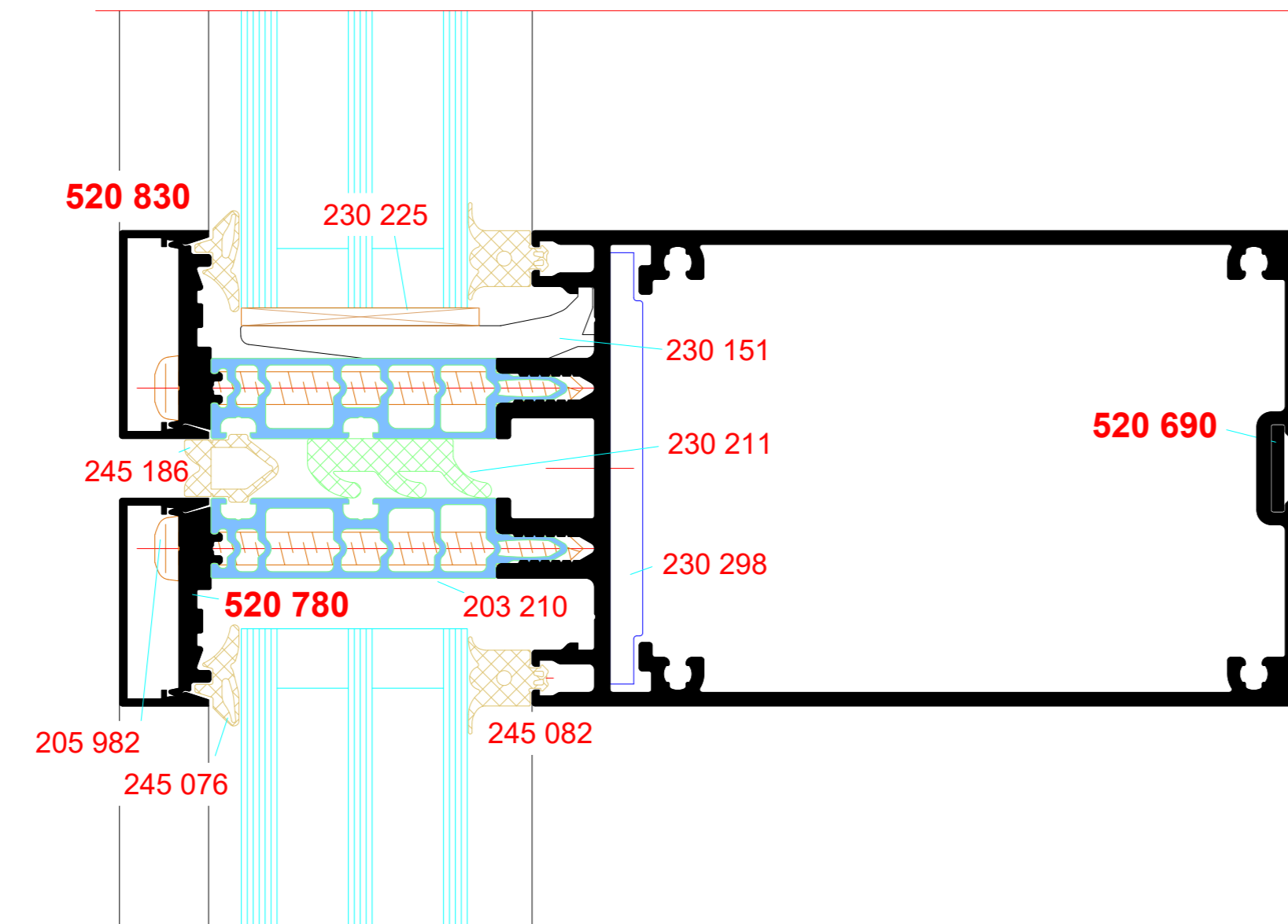
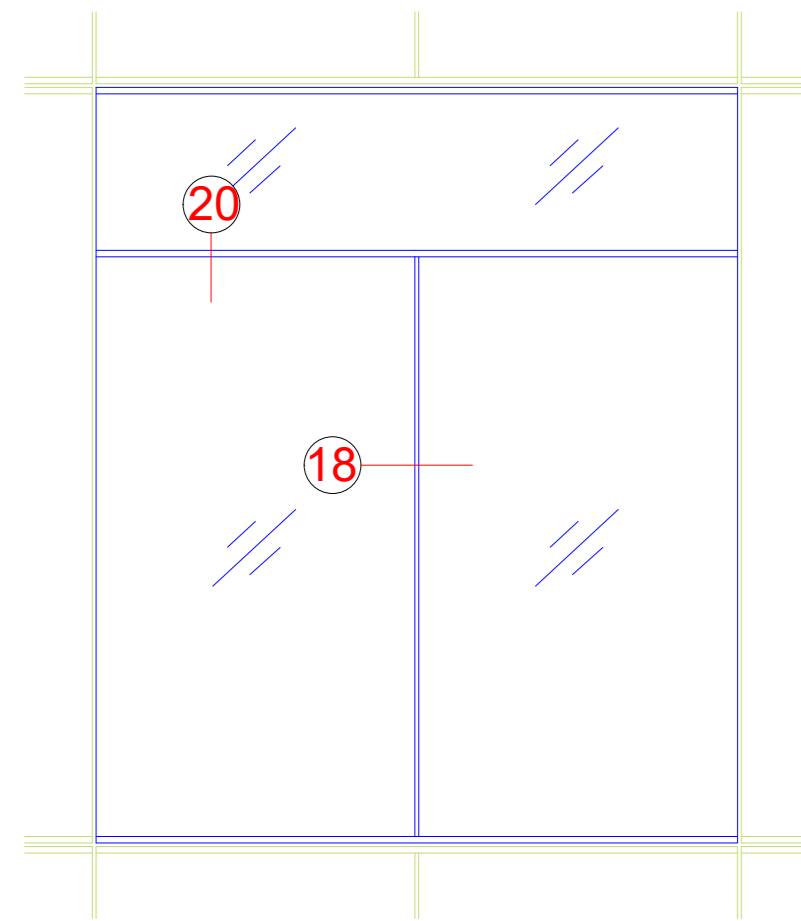

Sprosse, 80 mm Ansichtsbreite

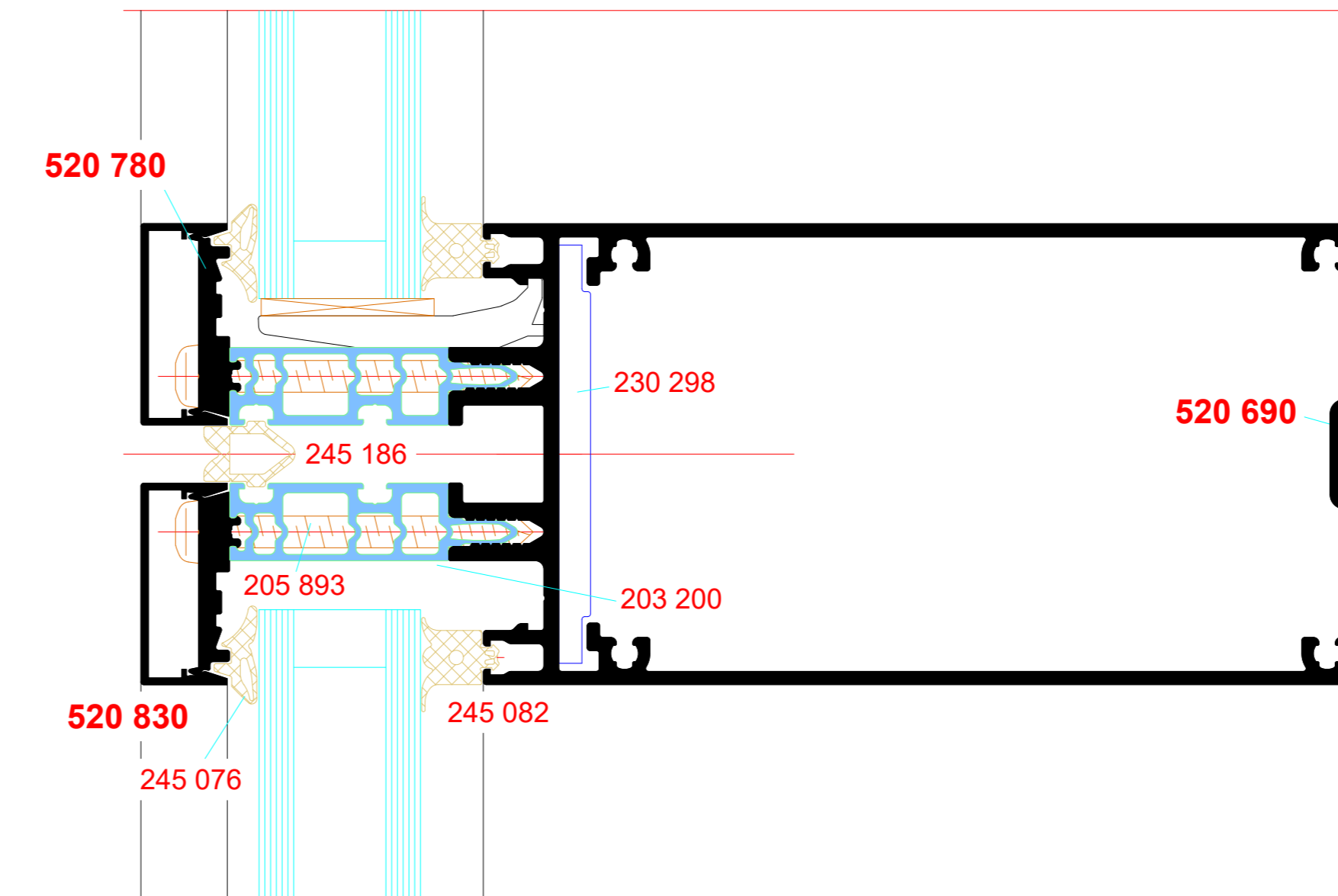

Sprosse, 80 mm Ansichtsbreite

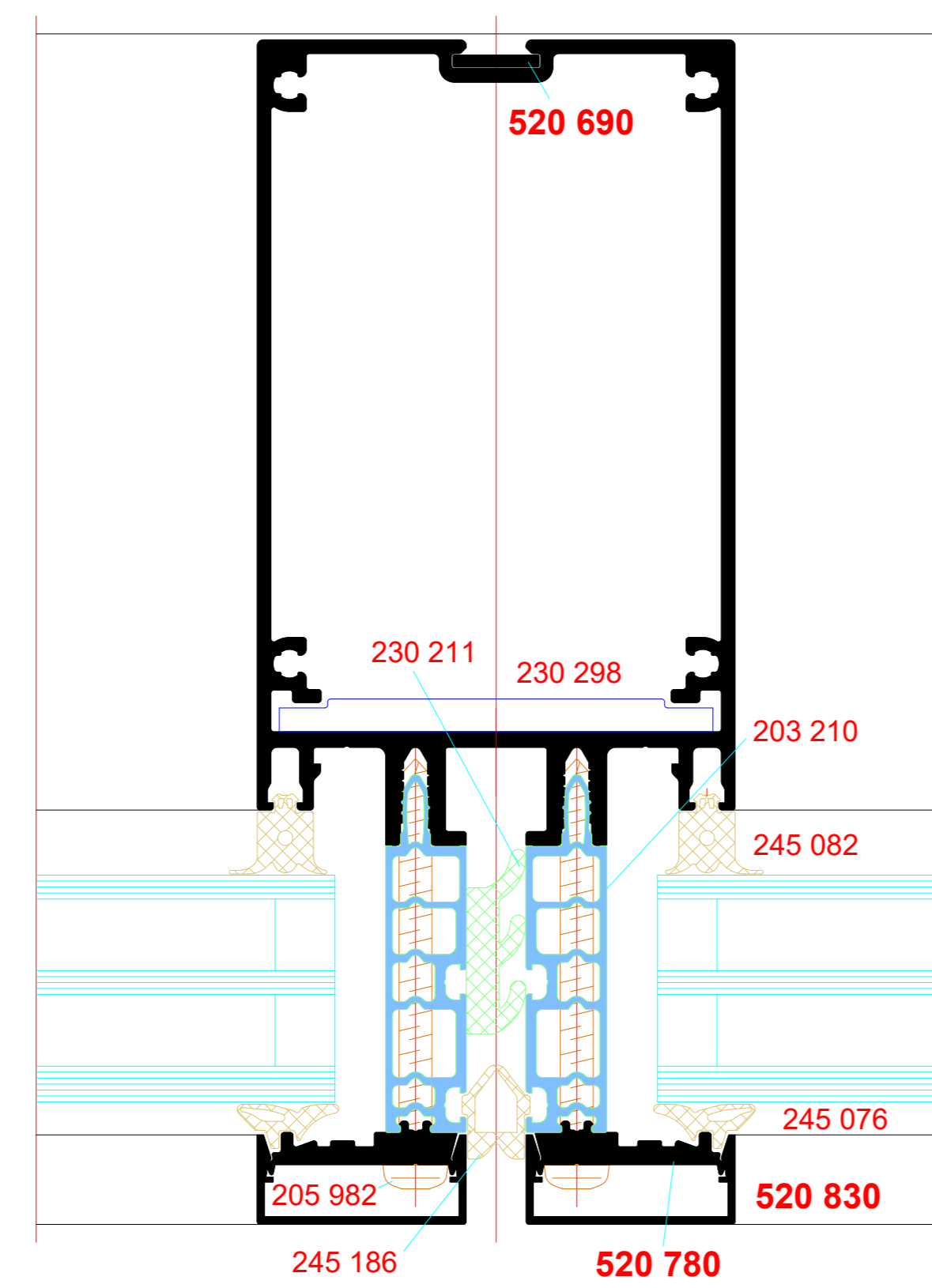

Sprosse, 80 mm Ansichtsbreite

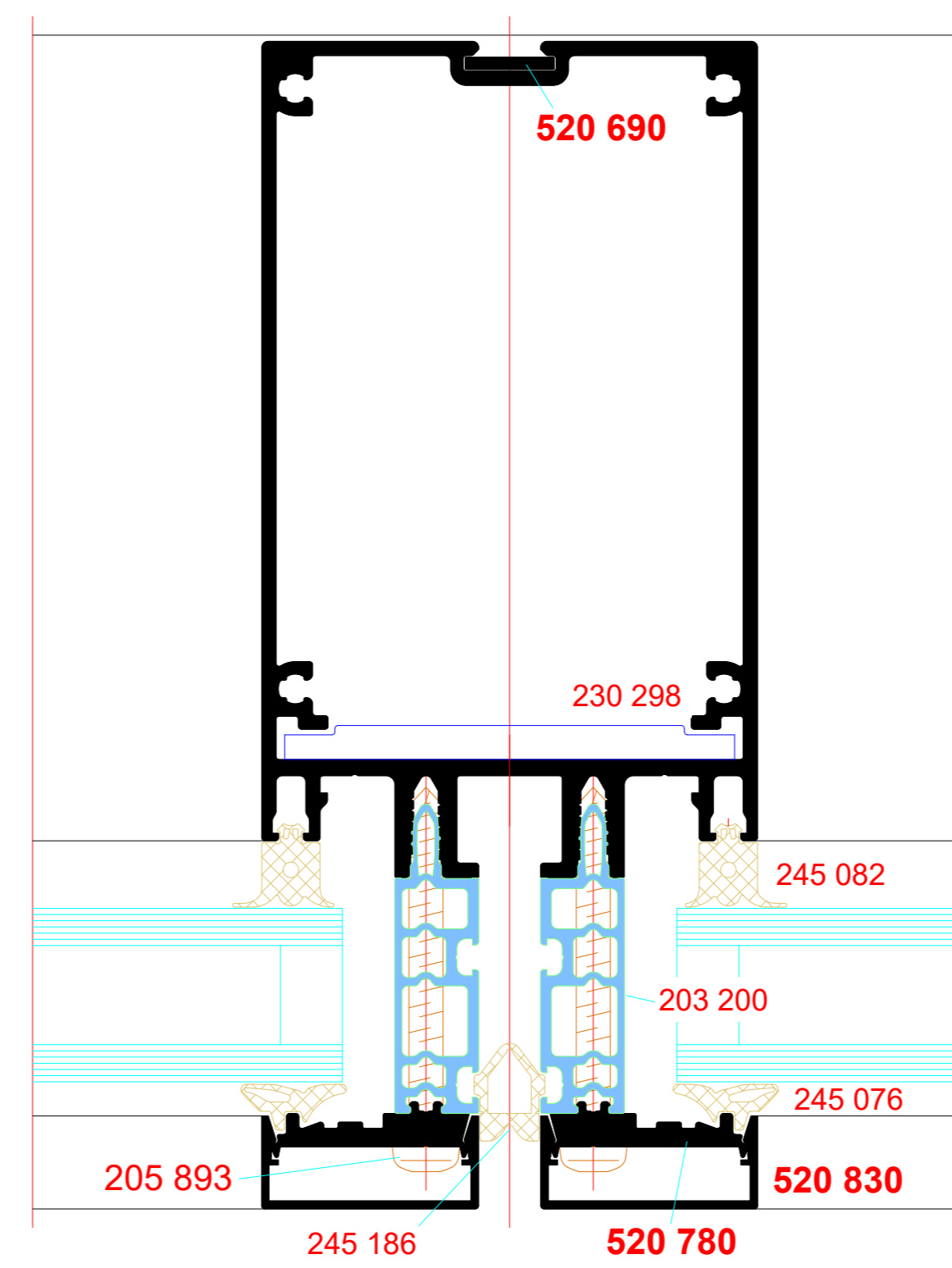

opake Fläche, auskragend
Rahmen, 10 mm Dehnfuge

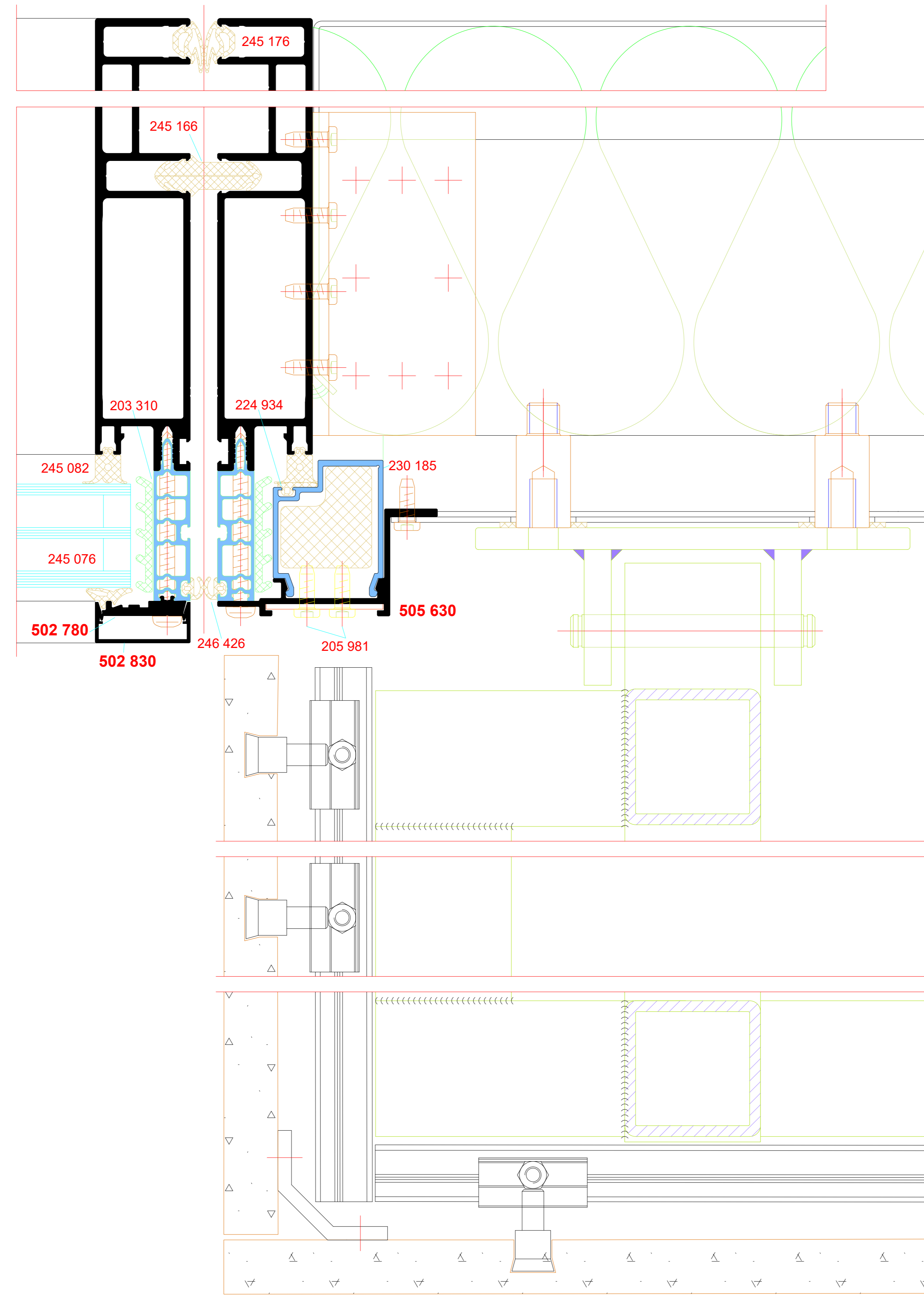
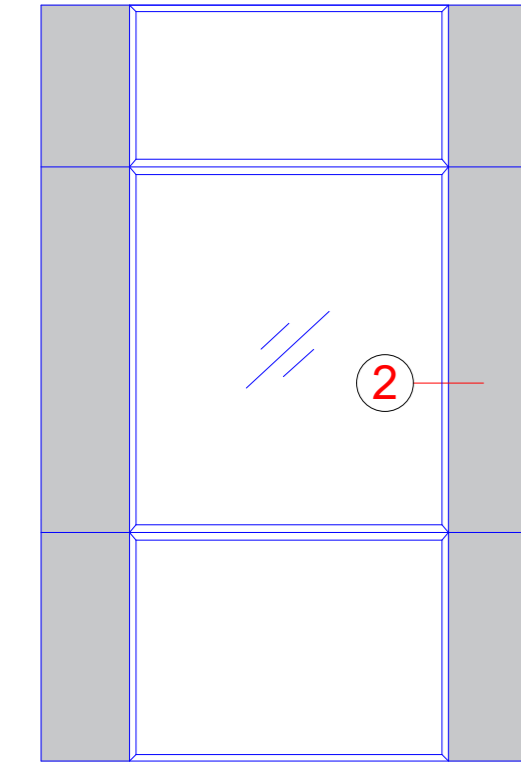

*Hinweis:
Nicht mit allen Bautiefen realisierbar!

opake Fläche, auskragend
Rahmen, 10 mm Dehnfuge

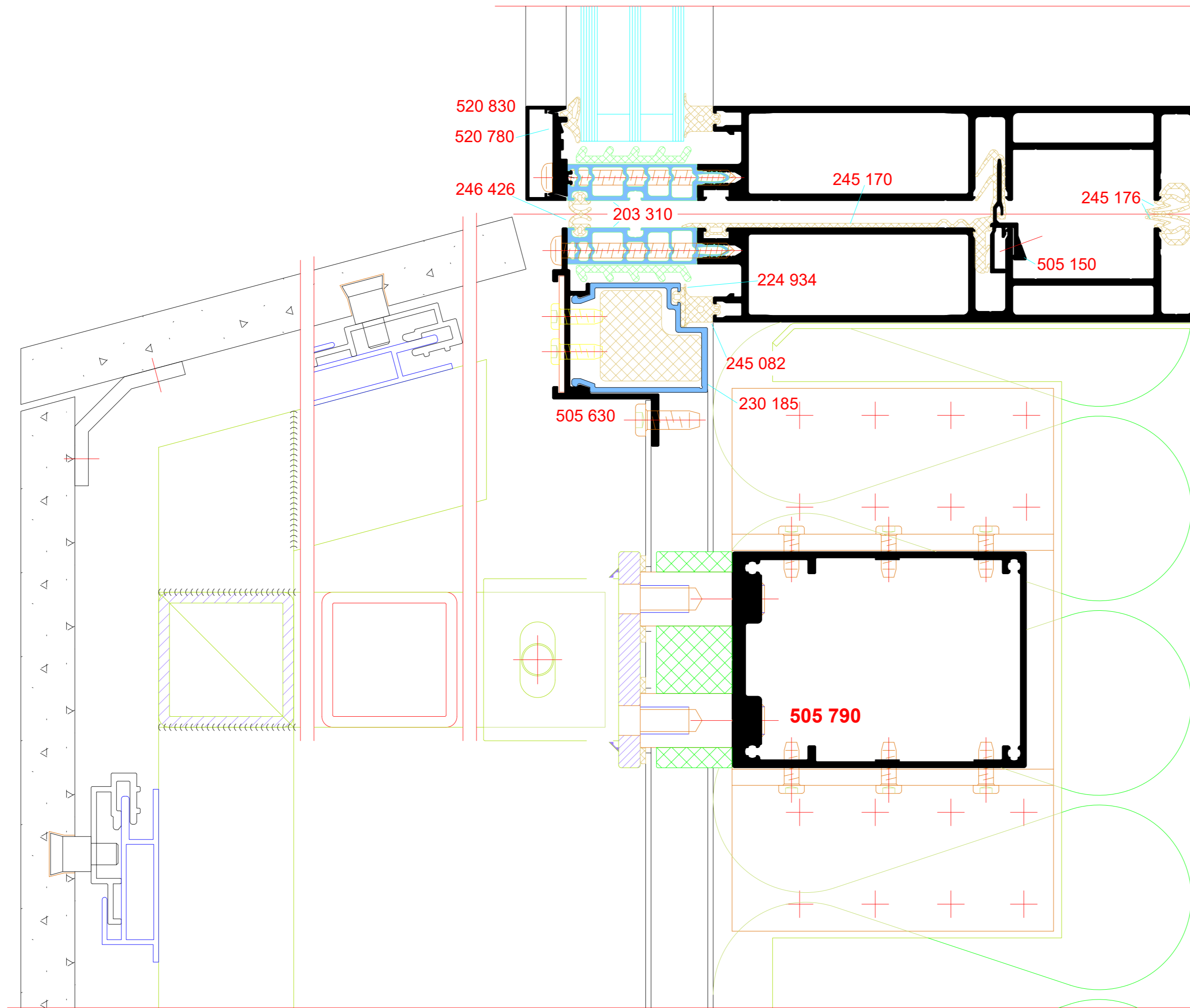
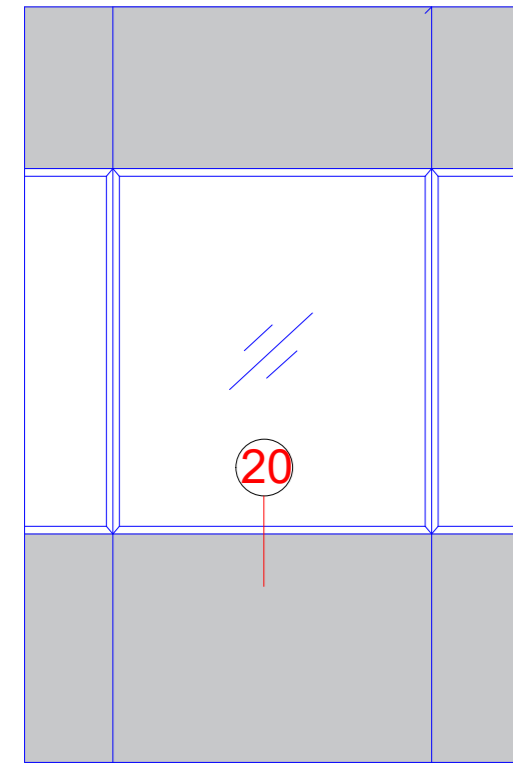

*Hinweis:
Nicht mit allen Bautiefen realisierbar!

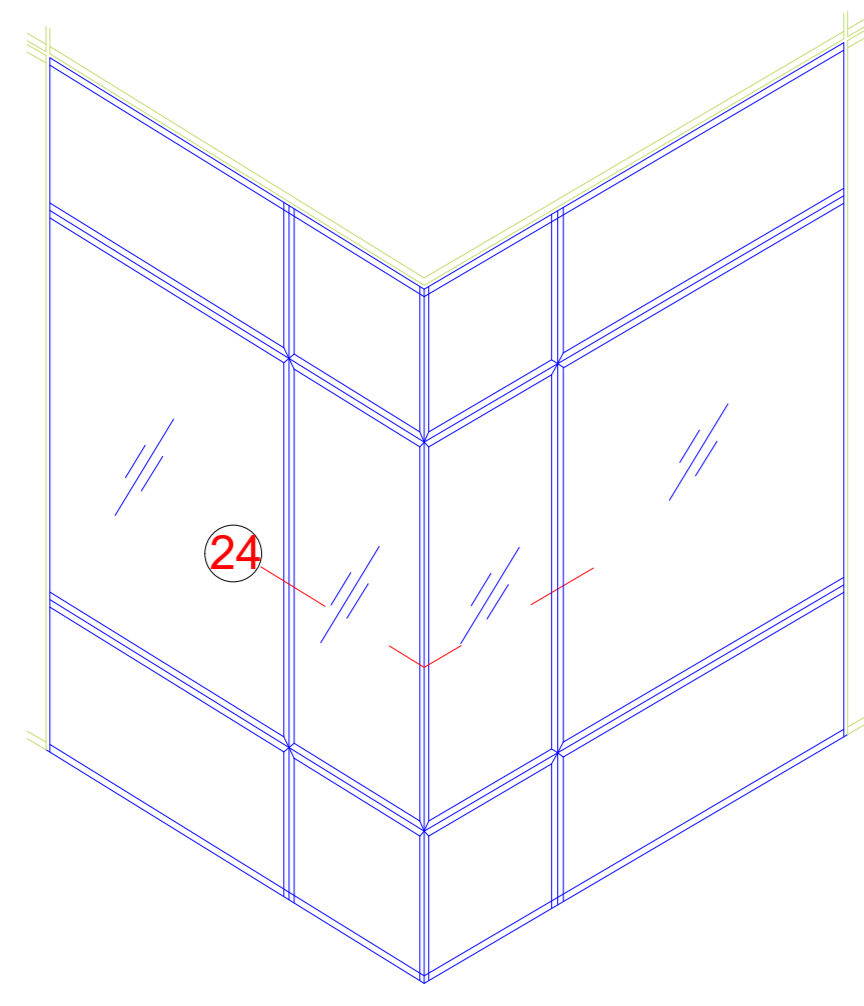

Außenecke 90°

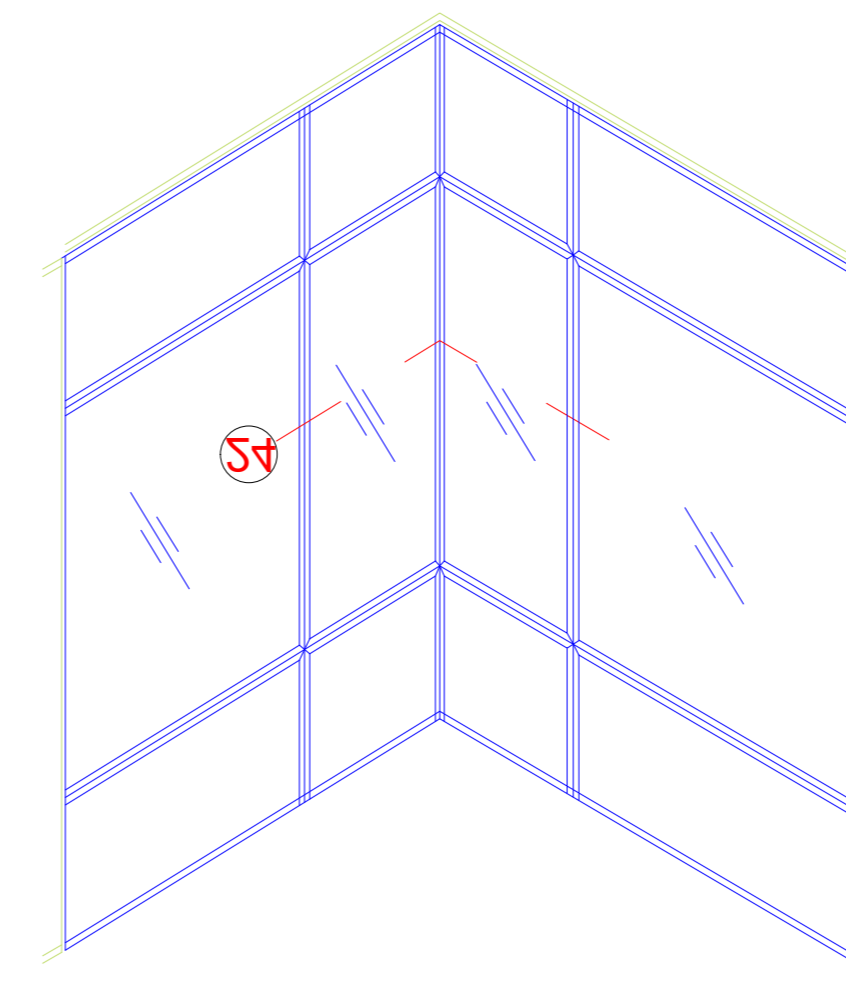
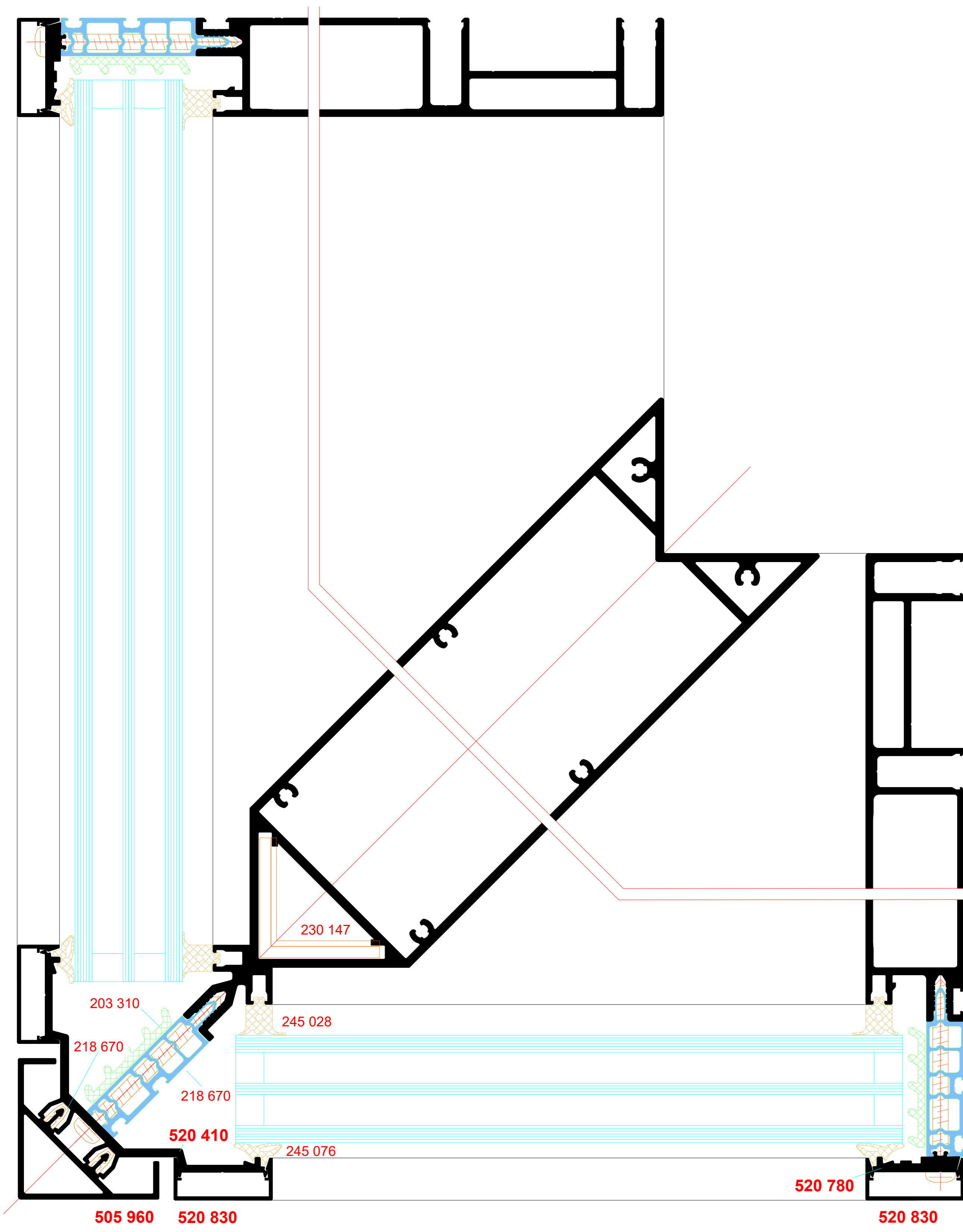

Innenecke 90°
Sprosse, 60 mm Ansichtsbreite

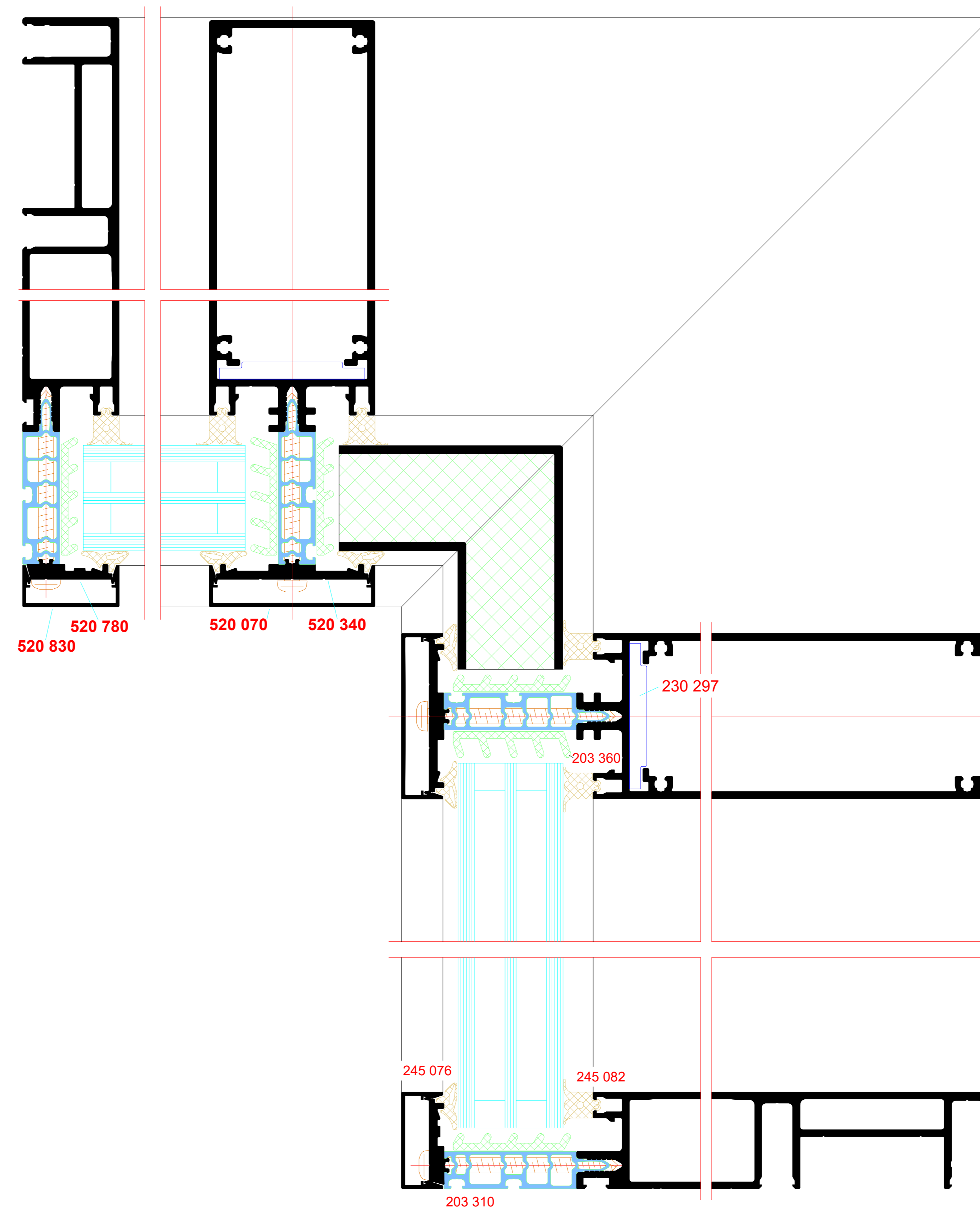

Brüstungssicherung

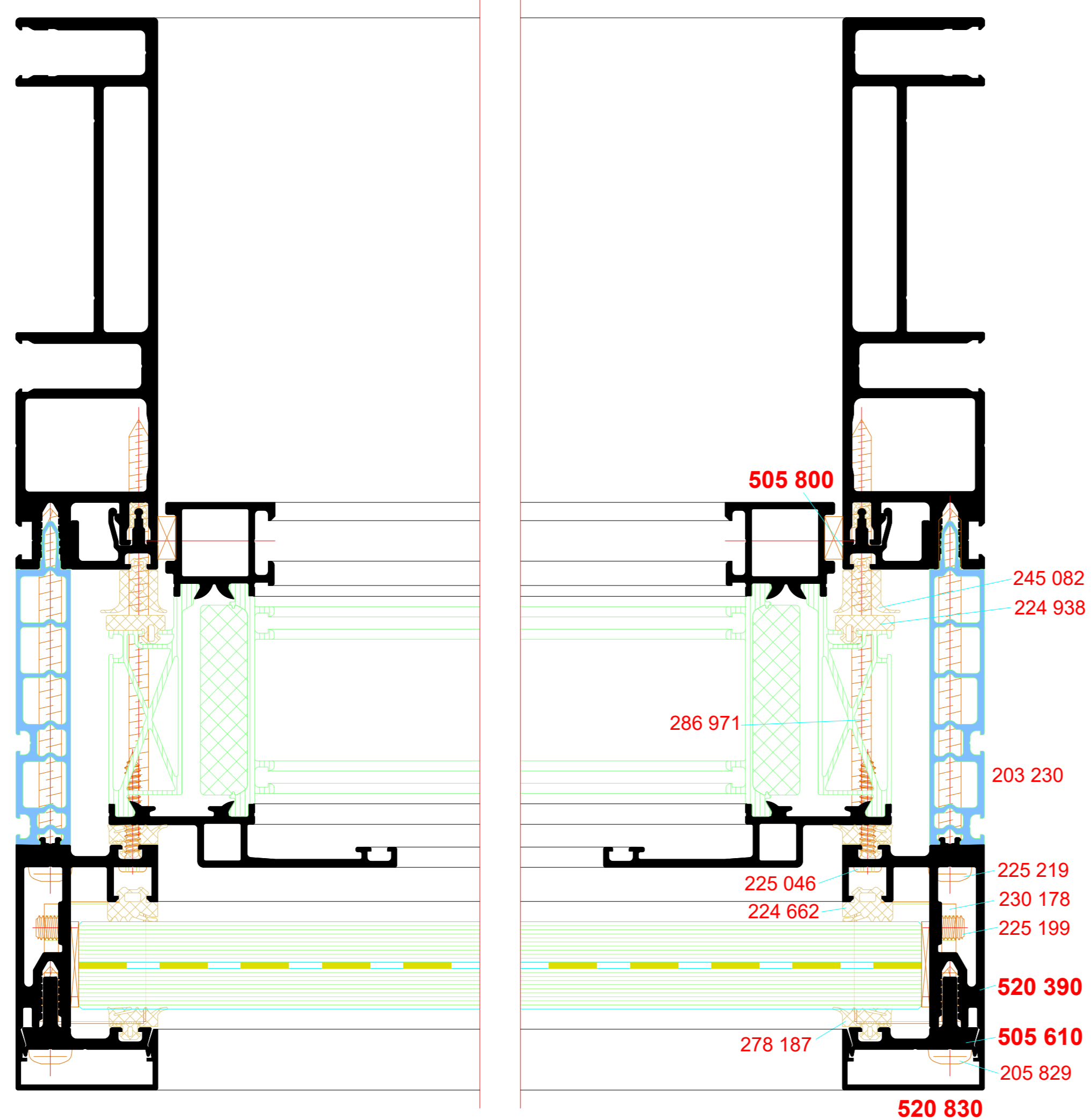
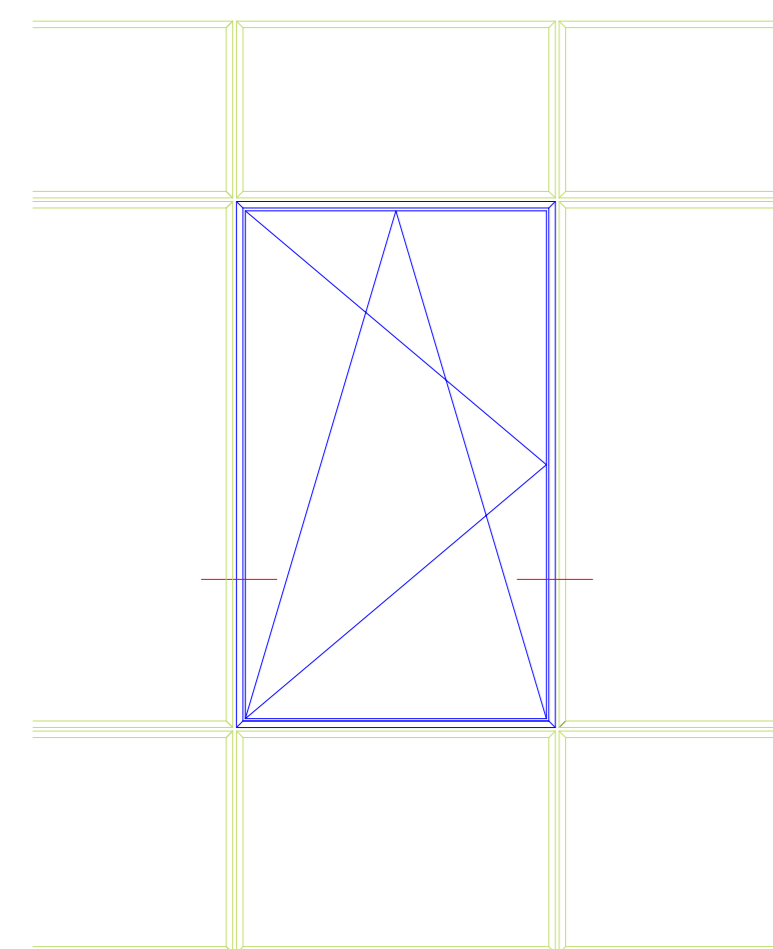

Brüstungssicherung

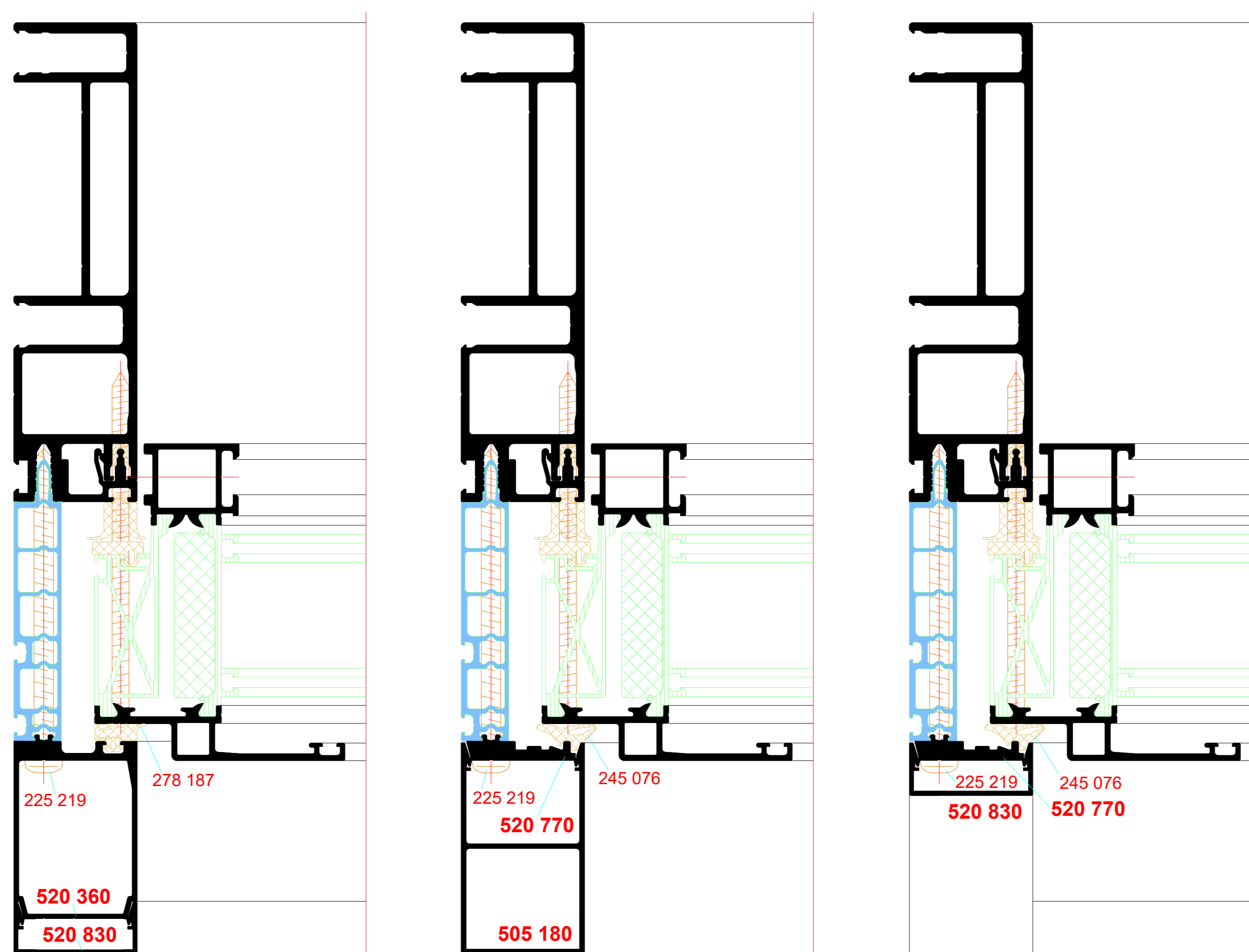

Brüstungssicherung

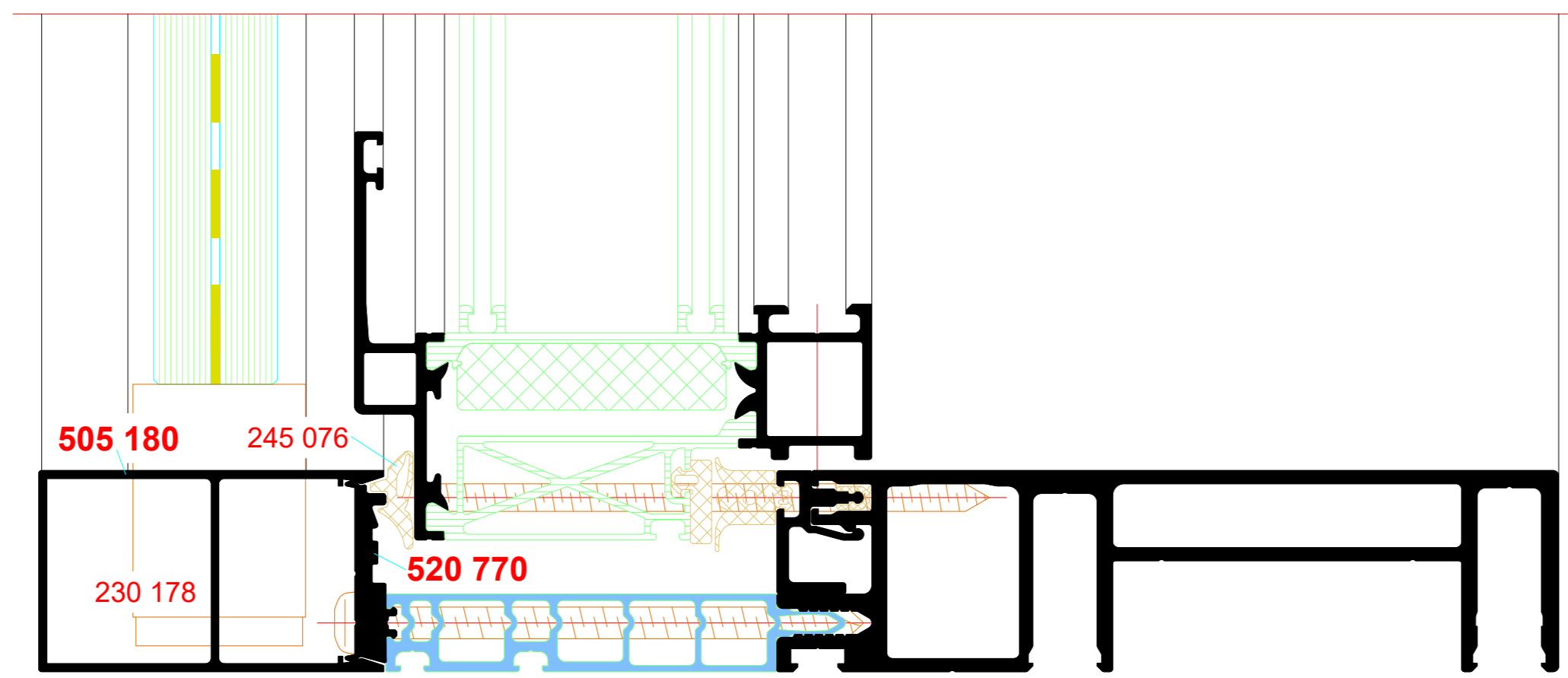
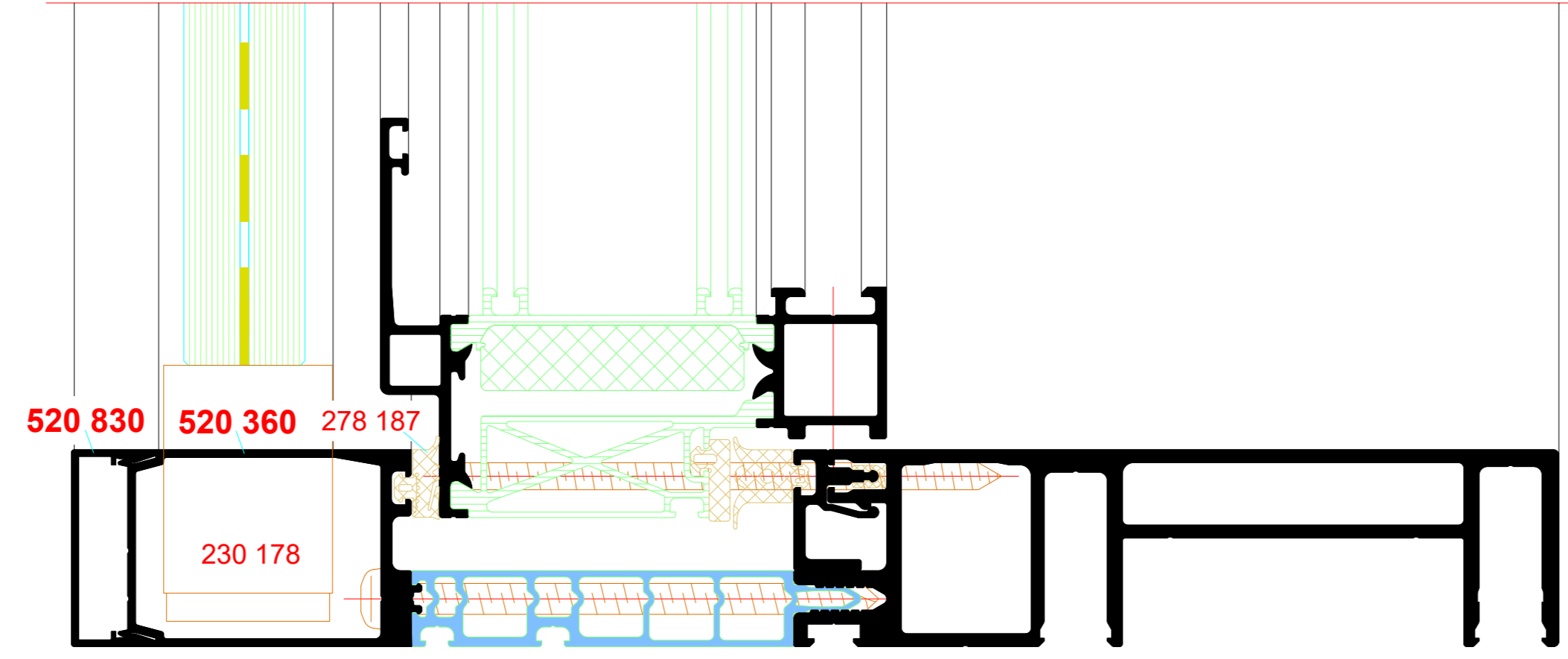
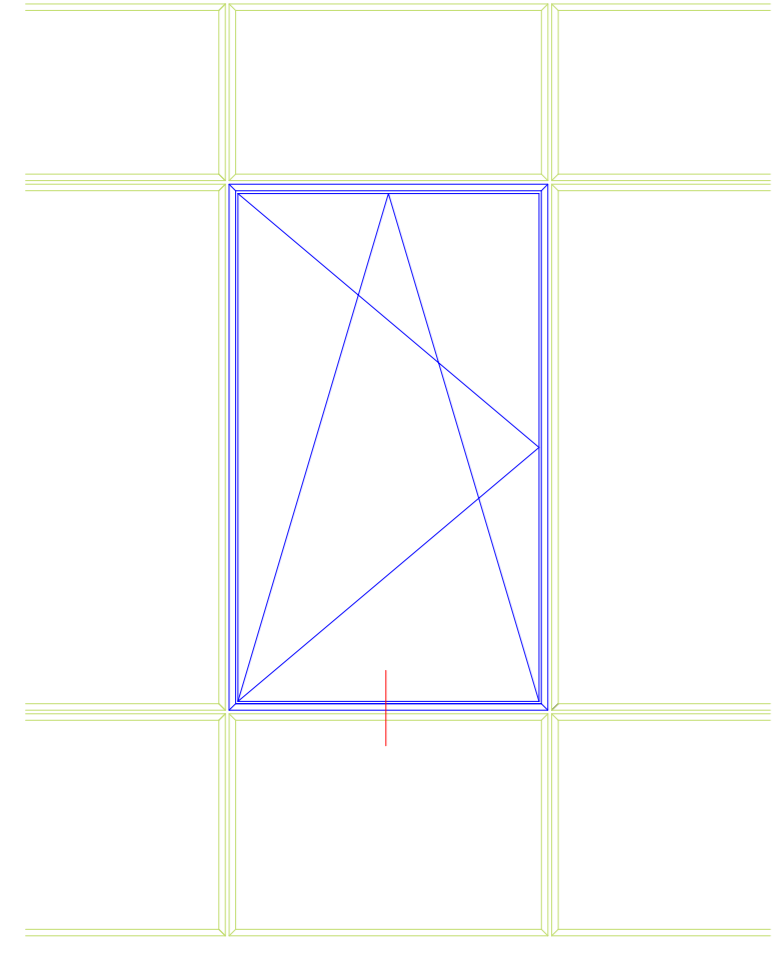

Seitlicher Baukörperanschluss

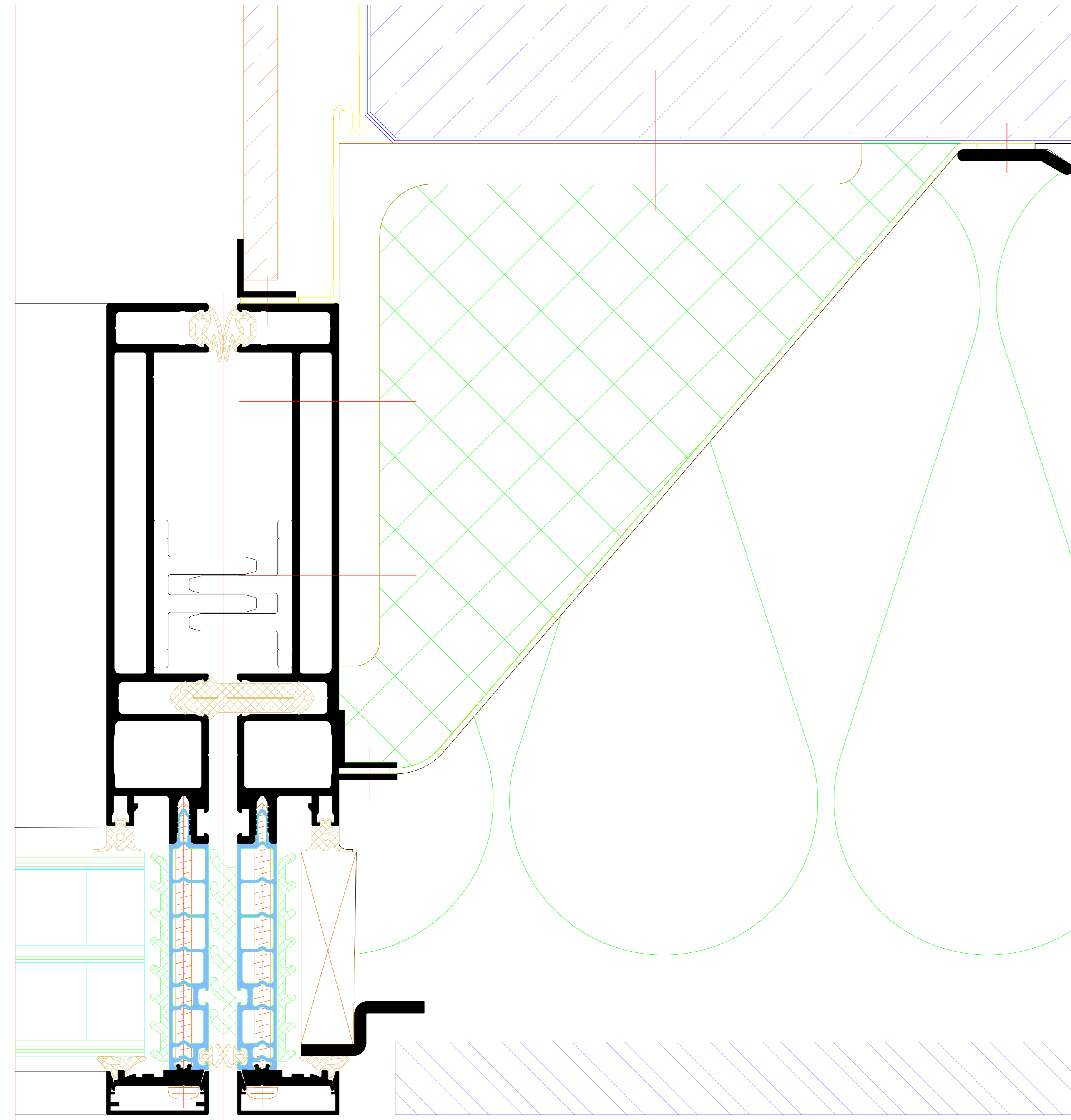

Unterer Baukörperanschluss

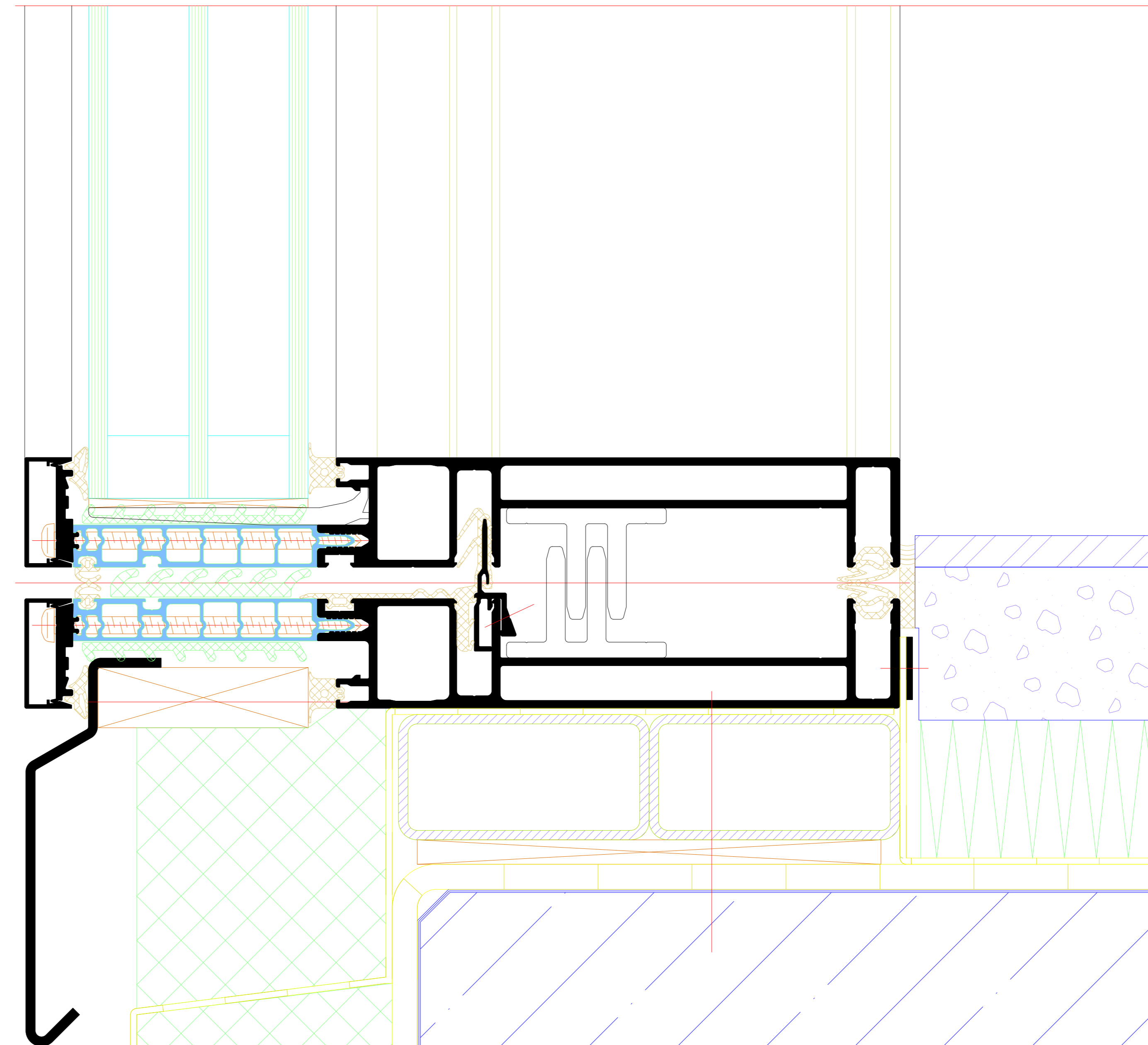

Attika

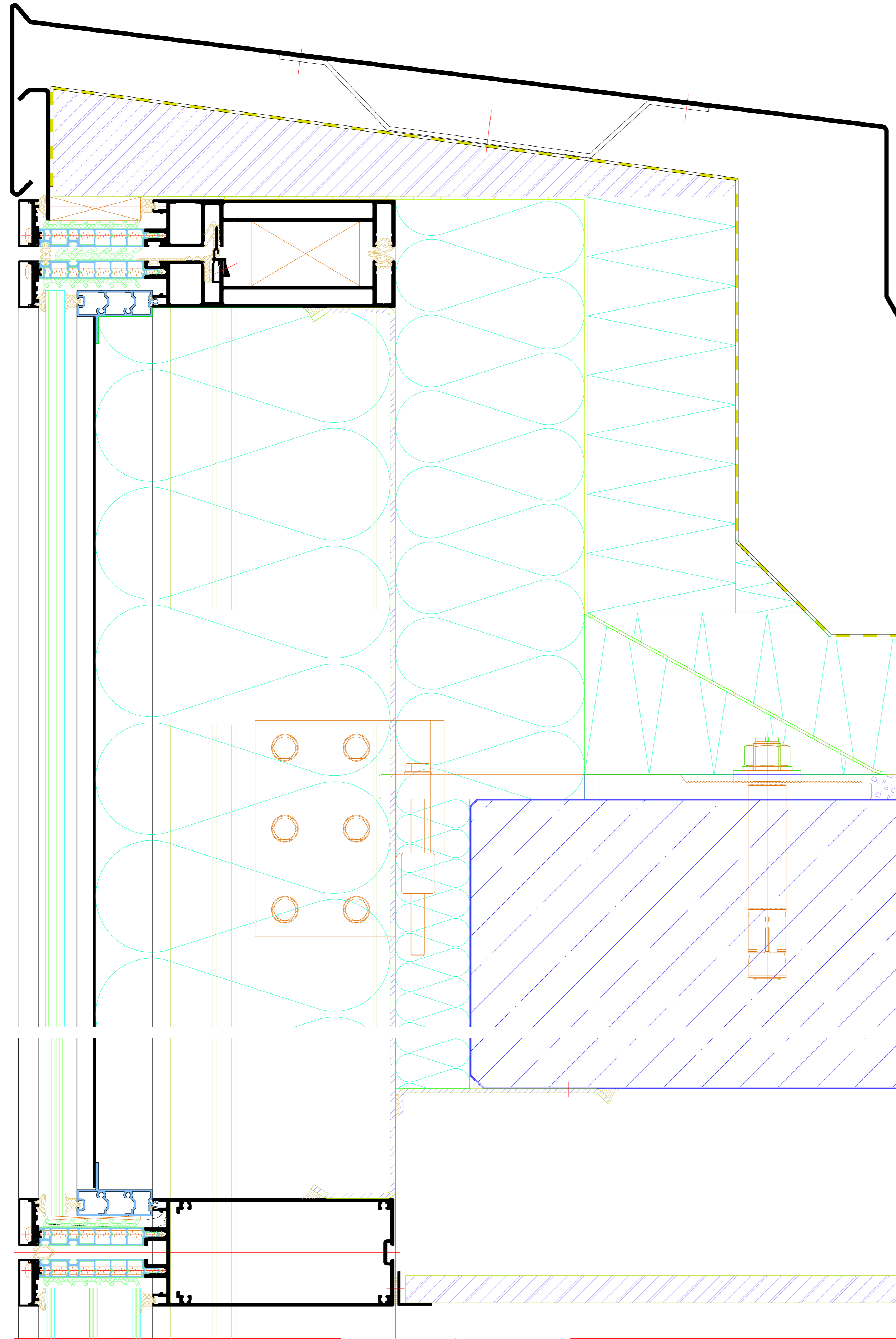

NO.	DATE	REVISION	DESIGNED BY	CHECKED BY
001	01.10.2023	01	BRUNO	BRUNO
002	02.10.2023	02	BRUNO	BRUNO
003	03.10.2023	03	BRUNO	BRUNO
004	04.10.2023	04	BRUNO	BRUNO
005	05.10.2023	05	BRUNO	BRUNO
006	06.10.2023	06	BRUNO	BRUNO
007	07.10.2023	07	BRUNO	BRUNO
008	08.10.2023	08	BRUNO	BRUNO
009	09.10.2023	09	BRUNO	BRUNO
010	10.10.2023	10	BRUNO	BRUNO
011	11.10.2023	11	BRUNO	BRUNO
012	12.10.2023	12	BRUNO	BRUNO
013	13.10.2023	13	BRUNO	BRUNO
014	14.10.2023	14	BRUNO	BRUNO
015	15.10.2023	15	BRUNO	BRUNO
016	16.10.2023	16	BRUNO	BRUNO
017	17.10.2023	17	BRUNO	BRUNO
018	18.10.2023	18	BRUNO	BRUNO
019	19.10.2023	19	BRUNO	BRUNO
020	20.10.2023	20	BRUNO	BRUNO
021	21.10.2023	21	BRUNO	BRUNO
022	22.10.2023	22	BRUNO	BRUNO
023	23.10.2023	23	BRUNO	BRUNO
024	24.10.2023	24	BRUNO	BRUNO
025	25.10.2023	25	BRUNO	BRUNO
026	26.10.2023	26	BRUNO	BRUNO
027	27.10.2023	27	BRUNO	BRUNO
028	28.10.2023	28	BRUNO	BRUNO
029	29.10.2023	29	BRUNO	BRUNO
030	30.10.2023	30	BRUNO	BRUNO
031	31.10.2023	31	BRUNO	BRUNO
032	01.11.2023	32	BRUNO	BRUNO
033	02.11.2023	33	BRUNO	BRUNO
034	03.11.2023	34	BRUNO	BRUNO
035	04.11.2023	35	BRUNO	BRUNO
036	05.11.2023	36	BRUNO	BRUNO
037	06.11.2023	37	BRUNO	BRUNO
038	07.11.2023	38	BRUNO	BRUNO
039	08.11.2023	39	BRUNO	BRUNO
040	09.11.2023	40	BRUNO	BRUNO
041	10.11.2023	41	BRUNO	BRUNO
042	11.11.2023	42	BRUNO	BRUNO
043	12.11.2023	43	BRUNO	BRUNO
044	13.11.2023	44	BRUNO	BRUNO
045	14.11.2023	45	BRUNO	BRUNO
046	15.11.2023	46	BRUNO	BRUNO
047	16.11.2023	47	BRUNO	BRUNO
048	17.11.2023	48	BRUNO	BRUNO
049	18.11.2023	49	BRUNO	BRUNO
050	19.11.2023	50	BRUNO	BRUNO
051	20.11.2023	51	BRUNO	BRUNO
052	21.11.2023	52	BRUNO	BRUNO
053	22.11.2023	53	BRUNO	BRUNO
054	23.11.2023	54	BRUNO	BRUNO
055	24.11.2023	55	BRUNO	BRUNO
056	25.11.2023	56	BRUNO	BRUNO
057	26.11.2023	57	BRUNO	BRUNO
058	27.11.2023	58	BRUNO	BRUNO
059	28.11.2023	59	BRUNO	BRUNO
060	29.11.2023	60	BRUNO	BRUNO
061	30.11.2023	61	BRUNO	BRUNO
062	01.12.2023	62	BRUNO	BRUNO
063	02.12.2023	63	BRUNO	BRUNO
064	03.12.2023	64	BRUNO	BRUNO
065	04.12.2023	65	BRUNO	BRUNO
066	05.12.2023	66	BRUNO	BRUNO
067	06.12.2023	67	BRUNO	BRUNO
068	07.12.2023	68	BRUNO	BRUNO
069	08.12.2023	69	BRUNO	BRUNO
070	09.12.2023	70	BRUNO	BRUNO
071	10.12.2023	71	BRUNO	BRUNO
072	11.12.2023	72	BRUNO	BRUNO
073	12.12.2023	73	BRUNO	BRUNO
074	13.12.2023	74	BRUNO	BRUNO
075	14.12.2023	75	BRUNO	BRUNO
076	15.12.2023	76	BRUNO	BRUNO
077	16.12.2023	77	BRUNO	BRUNO
078	17.12.2023	78	BRUNO	BRUNO
079	18.12.2023	79	BRUNO	BRUNO
080	19.12.2023	80	BRUNO	BRUNO
081	20.12.2023	81	BRUNO	BRUNO
082	21.12.2023	82	BRUNO	BRUNO
083	22.12.2023	83	BRUNO	BRUNO
084	23.12.2023	84	BRUNO	BRUNO
085	24.12.2023	85	BRUNO	BRUNO
086	25.12.2023	86	BRUNO	BRUNO
087	26.12.2023	87	BRUNO	BRUNO
088	27.12.2023	88	BRUNO	BRUNO
089	28.12.2023	89	BRUNO	BRUNO
090	29.12.2023	90	BRUNO	BRUNO
091	30.12.2023	91	BRUNO	BRUNO
092	31.12.2023	92	BRUNO	BRUNO
093	01.01.2024	93	BRUNO	BRUNO
094	02.01.2024	94	BRUNO	BRUNO
095	03.01.2024	95	BRUNO	BRUNO
096	04.01.2024	96	BRUNO	BRUNO
097	05.01.2024	97	BRUNO	BRUNO
098	06.01.2024	98	BRUNO	BRUNO
099	07.01.2024	99	BRUNO	BRUNO
100	08.01.2024	100	BRUNO	BRUNO