

Horizontalschnitt durch Rahmen AF UDC 80 SG, Verklebung mit Glaswechselrahmen
 Horizontal section detail through AF UDC 80 SG frame, bonding with glass replacement frame

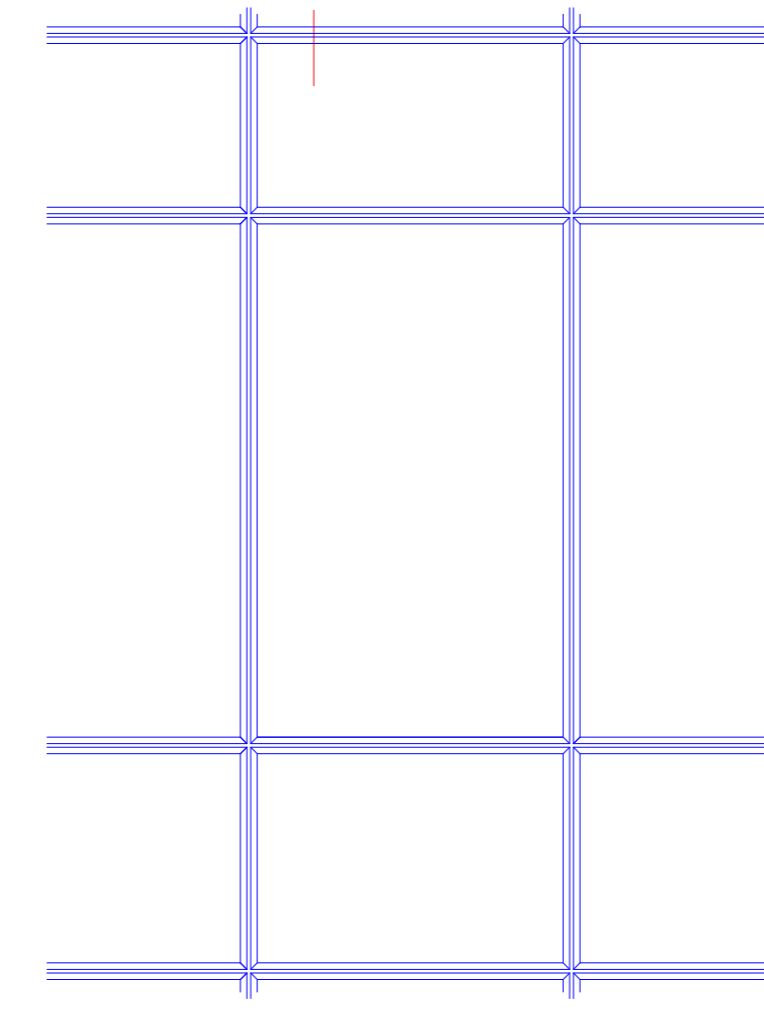

Vertikalschnitt durch Rahmen AF UDC 80 SG, Verklebung mit Glaswechselrahmen
 Vertical section detail through AF UDC 80 SG frame, bonding with glass replacement frame

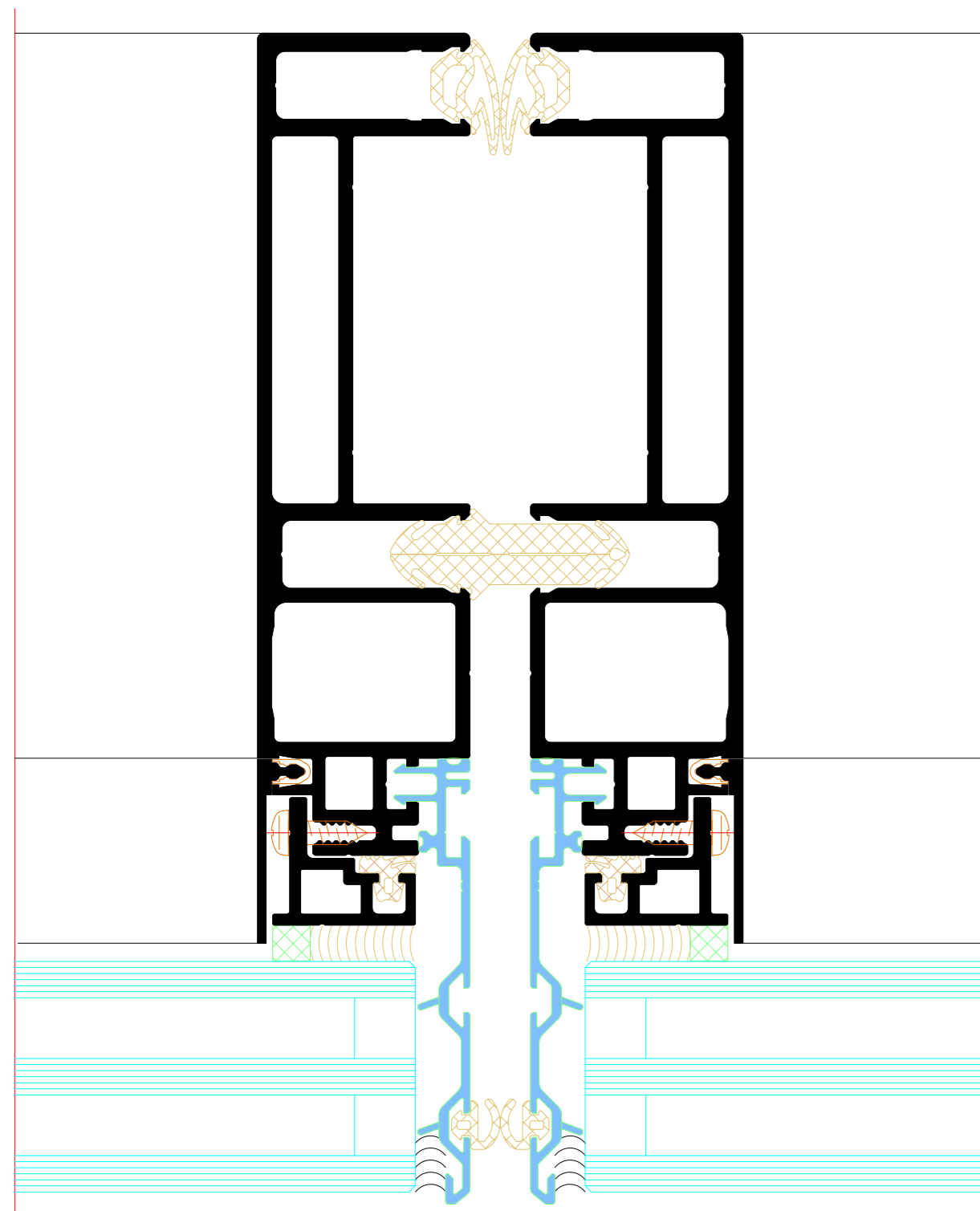

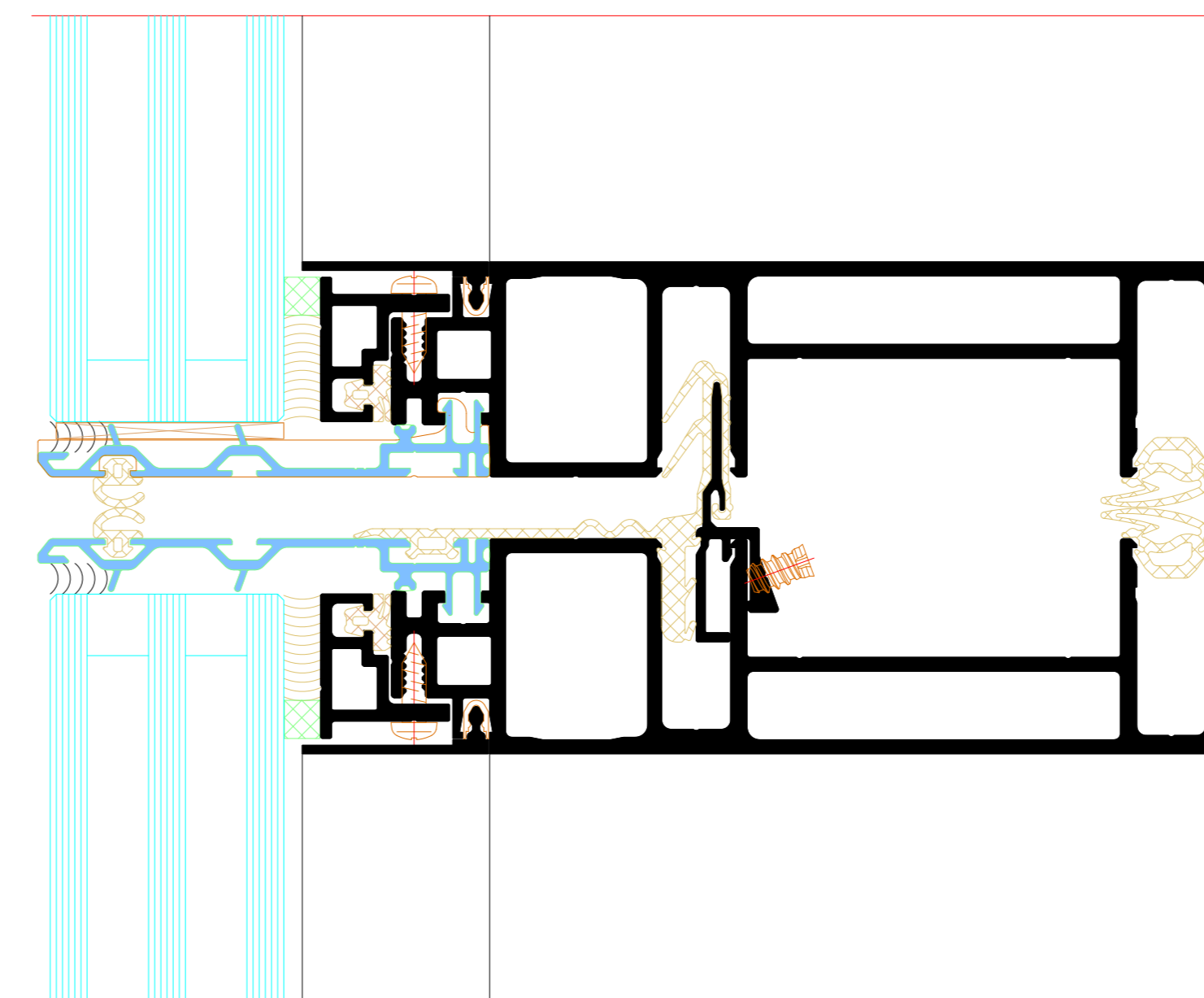
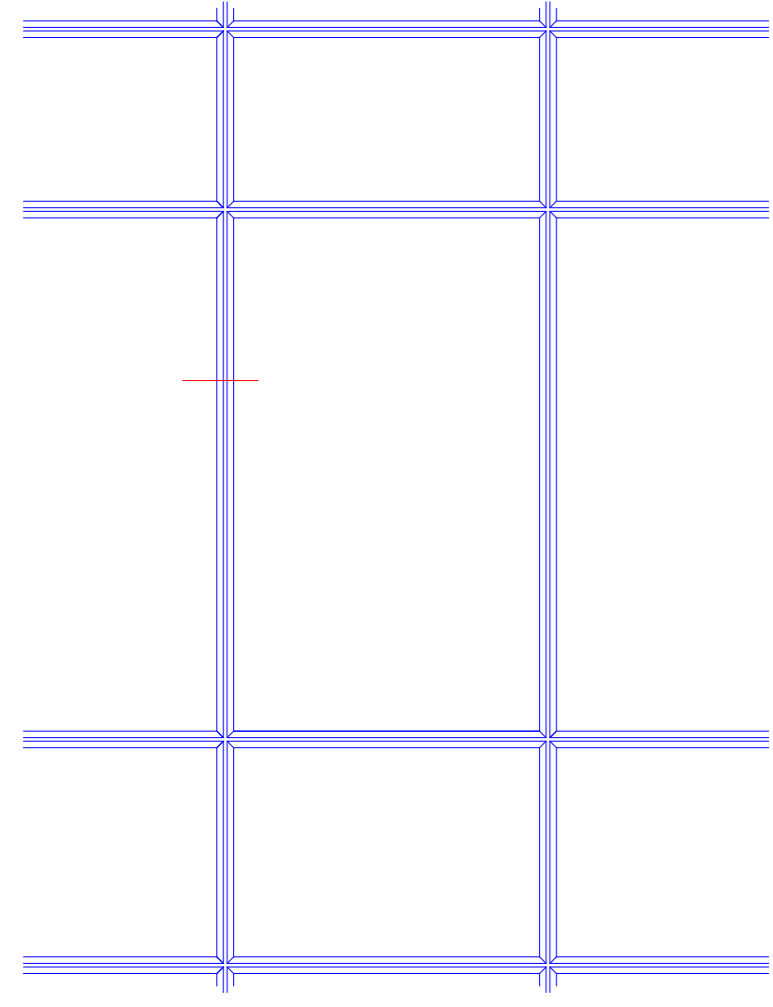

Horizontalschnitt durch Rahmen AF UDC 80 SG, Direktverklebung
Horizontal section detail through AF UDC 80 SG frame, direct bonding

10 mm Fuge
10 mm joint

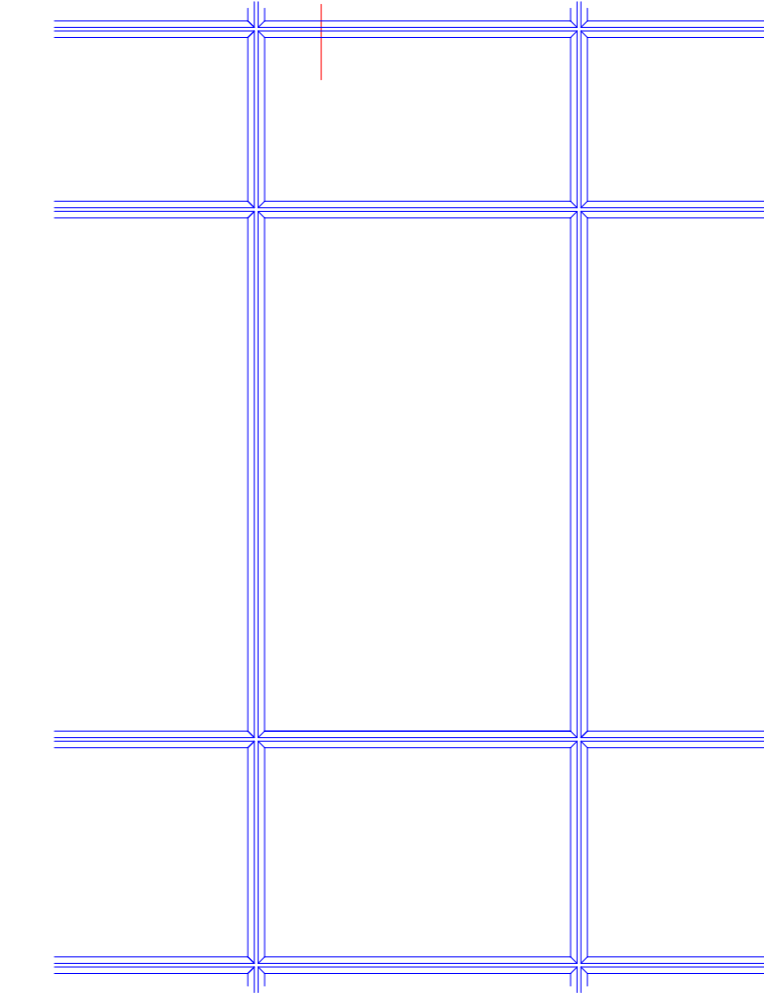
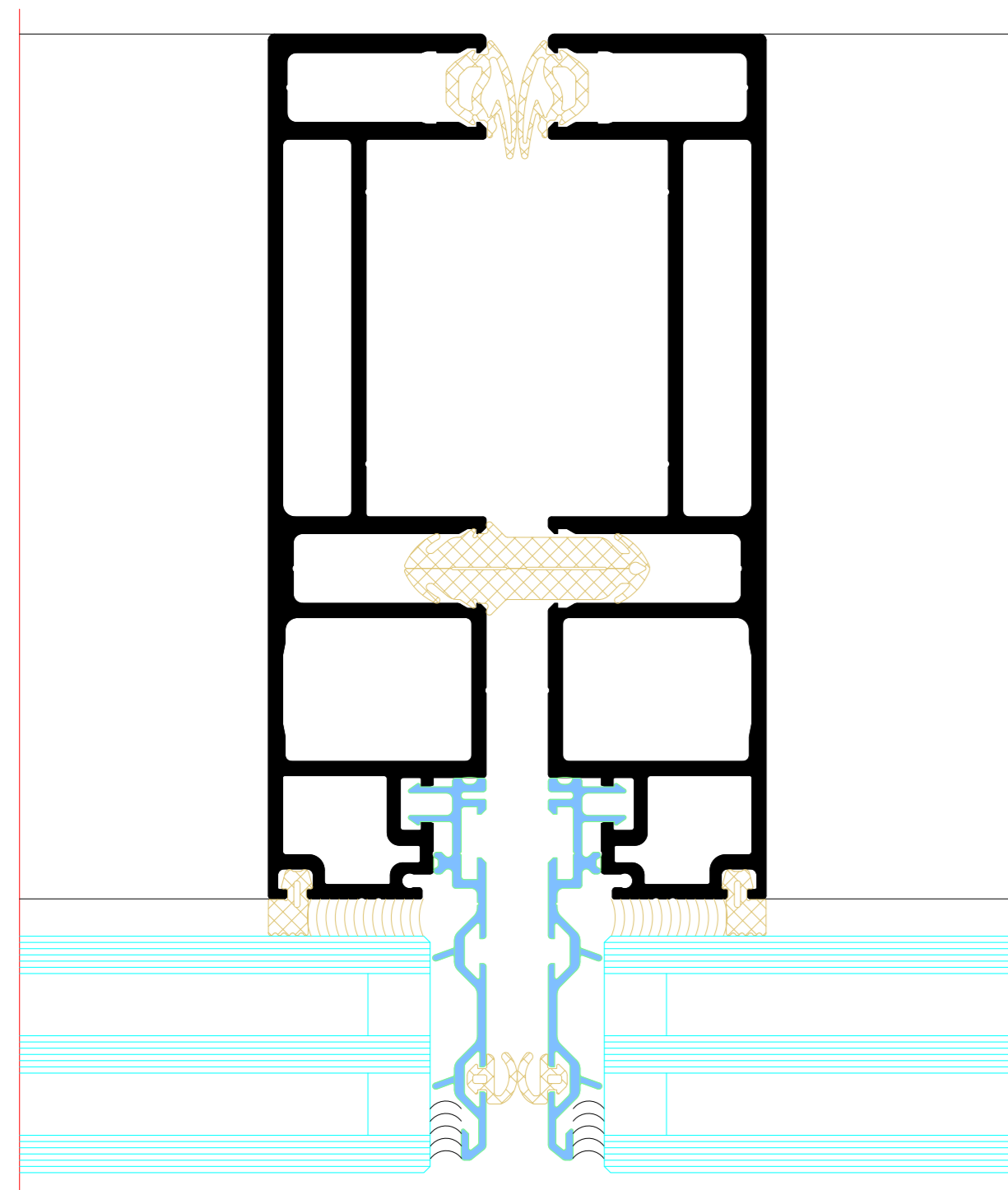

Vertikalschnitt durch Rahmen AF UDC 80 SG, Direktverklebung
Vertical section detail through AF UDC 80 SG frame, direct bonding

10 mm Fuge
10 mm joint

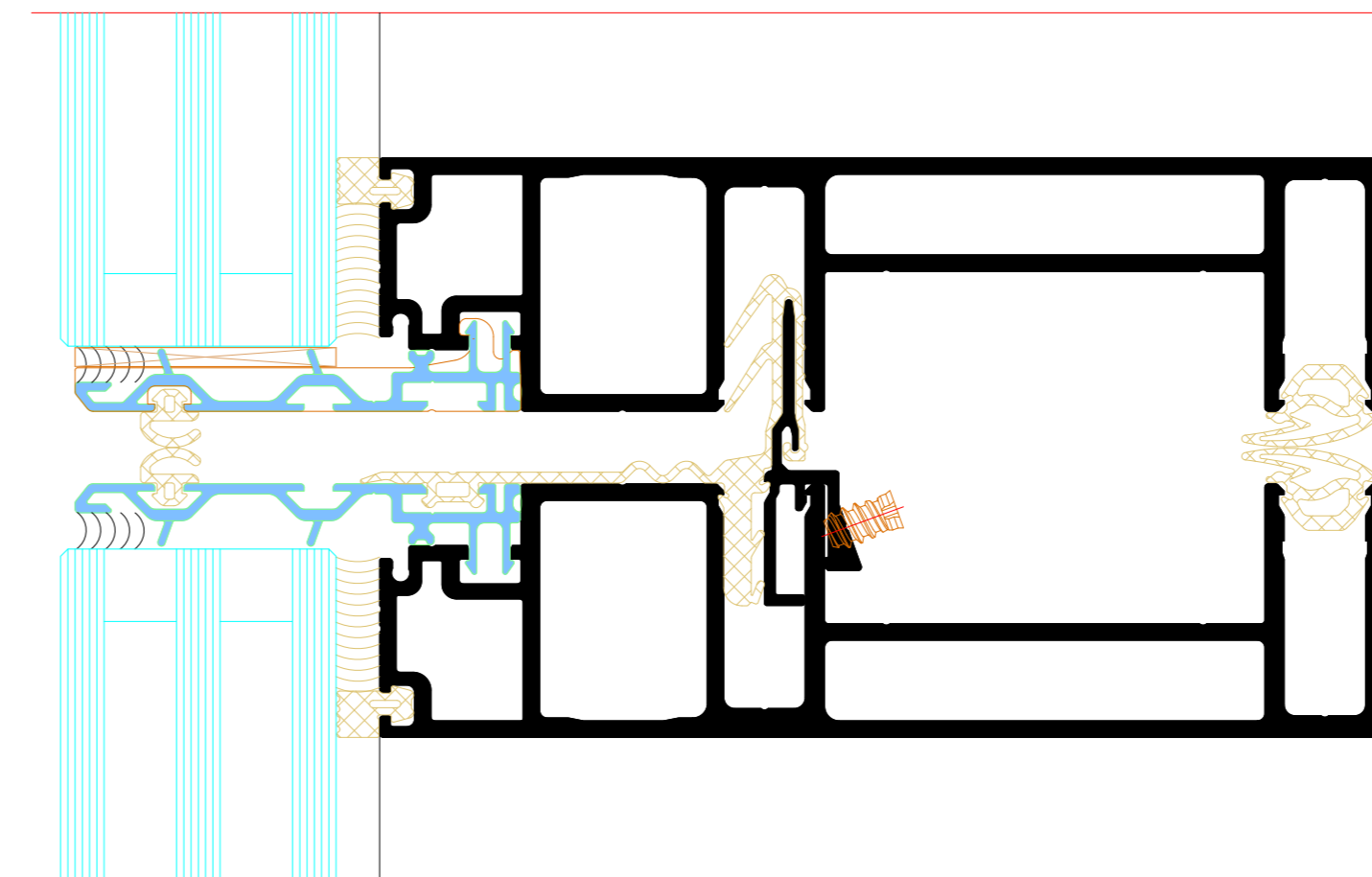

Vertikalschnitt durch Sprosse AF UDC 80 SG, Direktverklebung
Vertical section detail through AF UDC 80 SG sash bar, direct bonding

10 mm Fuge
10 mm joint

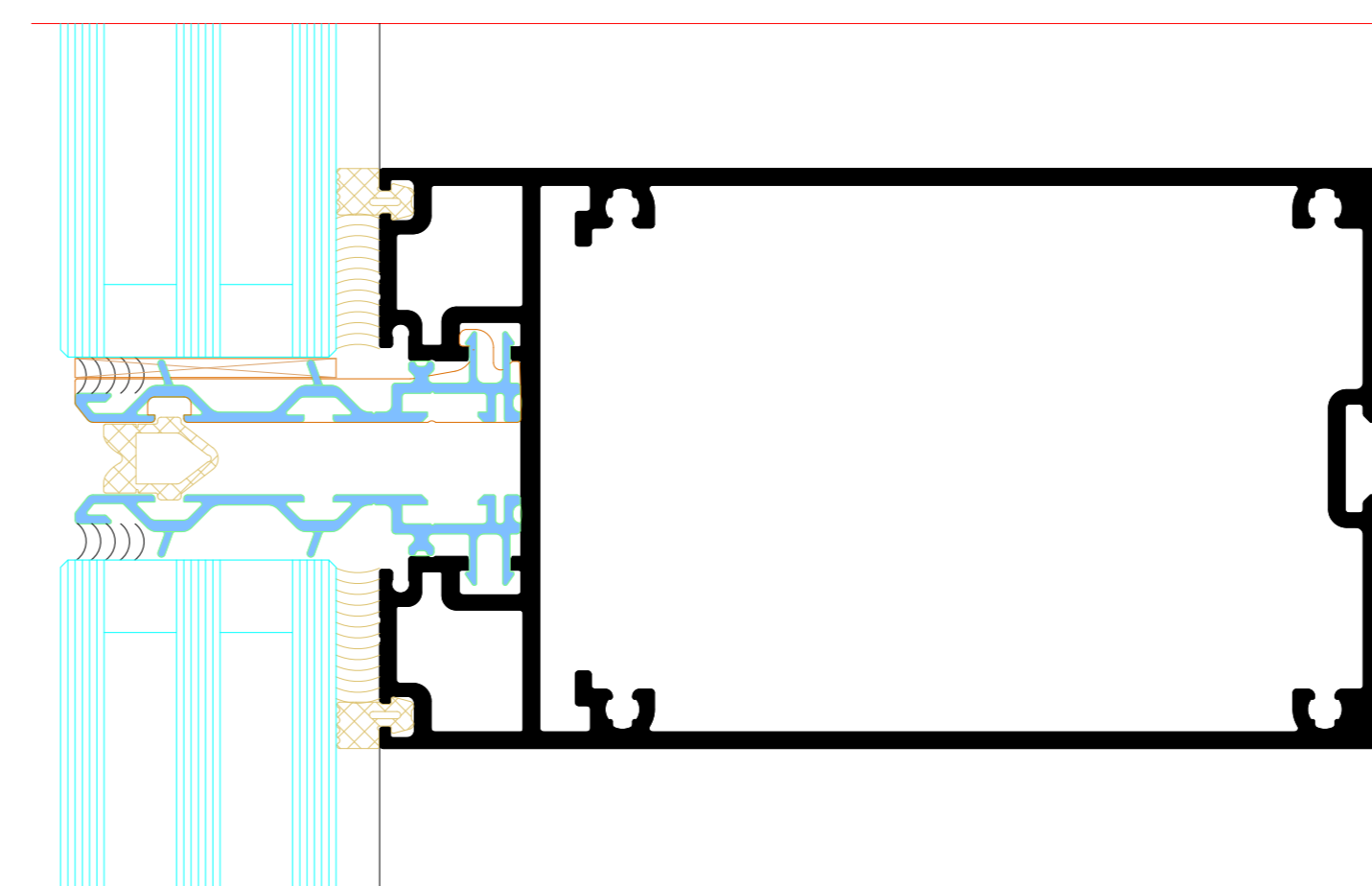

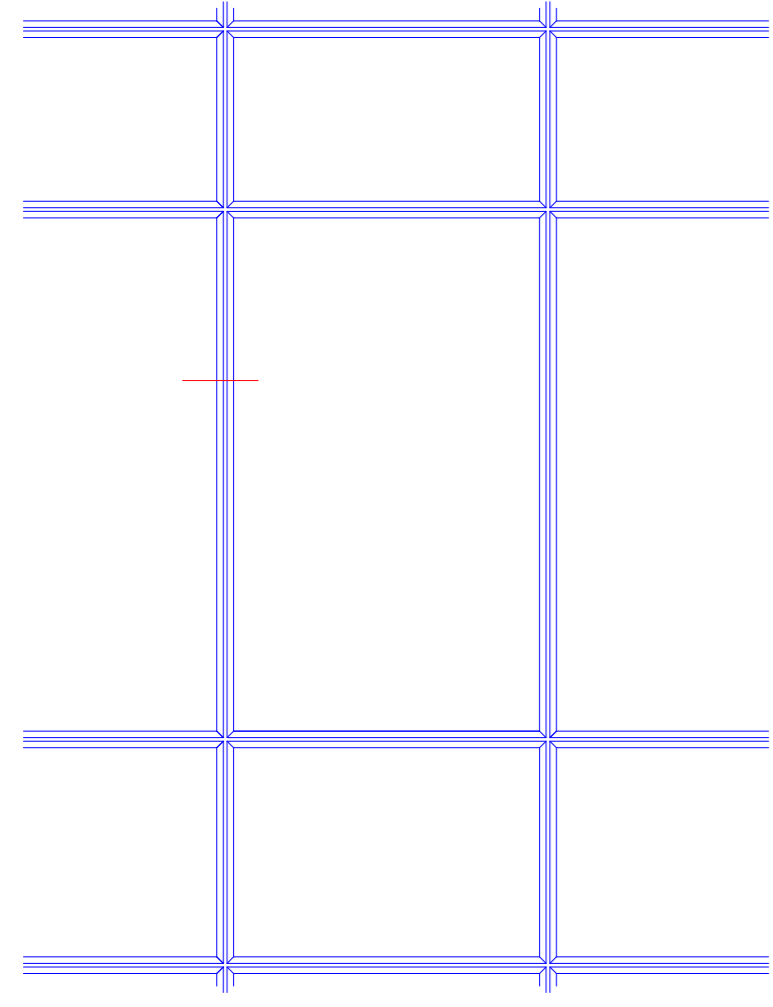

Horizontalschnitt durch Rahmen AF UDC 80 SG, Direktverklebung
Horizontal section detail through AF UDC 80 SG frame, direct bonding

15 mm Fuge
15 mm joint

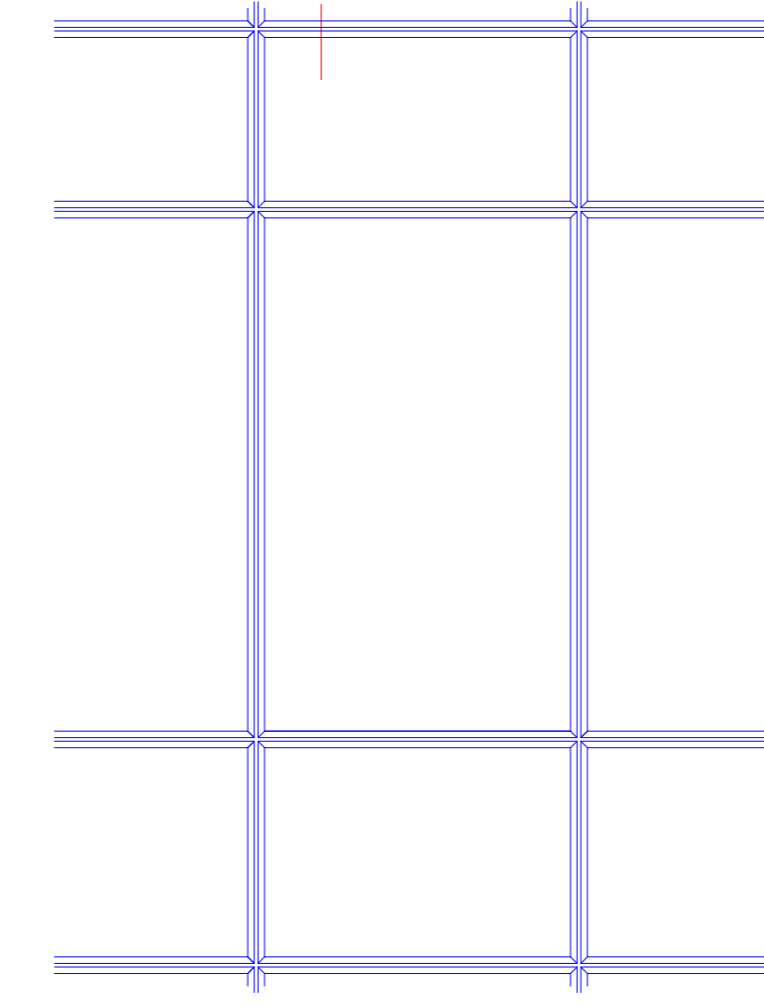
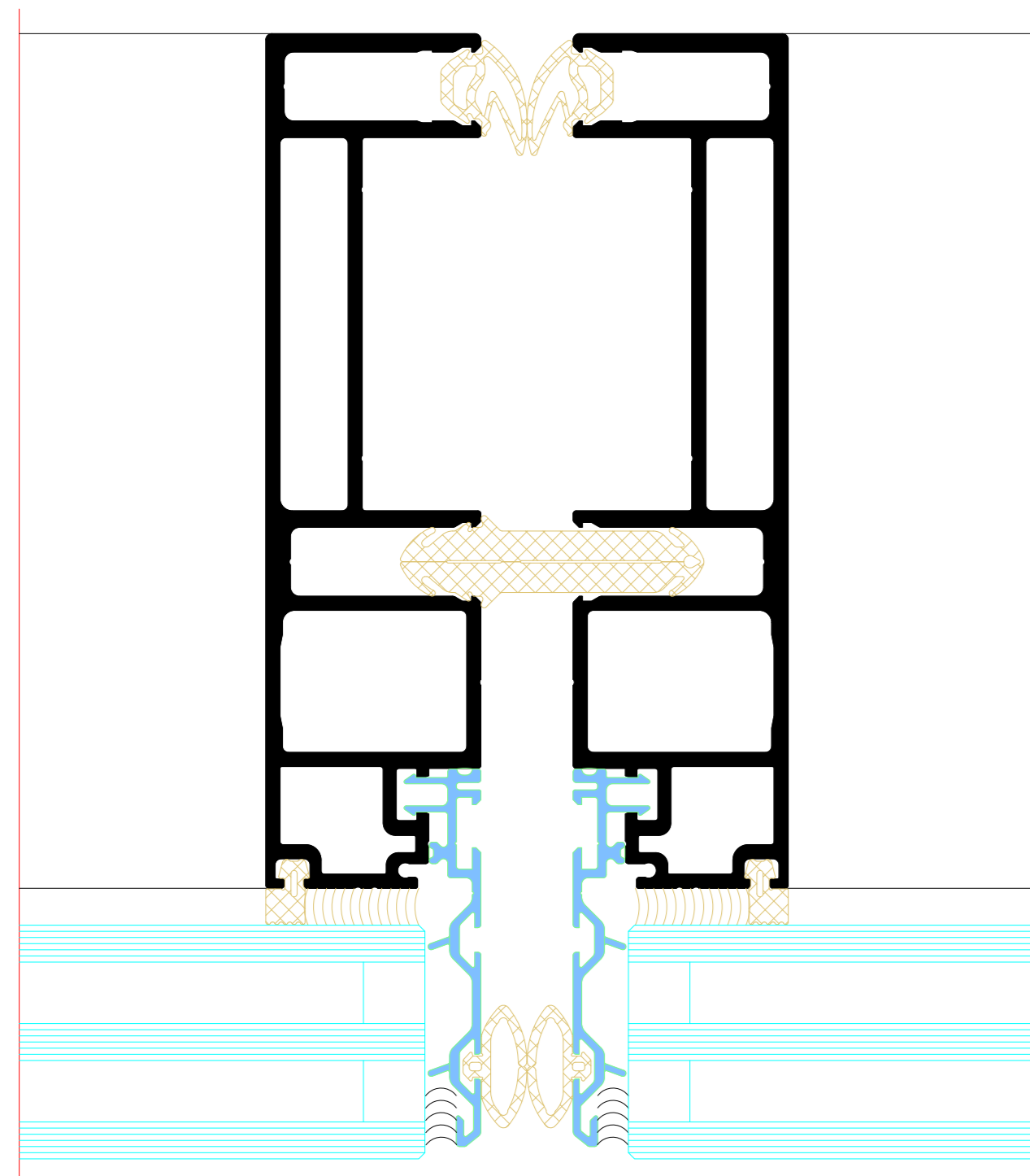

Vertikalschnitt durch Rahmen AF UDC 80 SG, Direktverklebung
Vertical section detail through AF UDC 80 SG frame, direct bonding

15 mm Fuge
15 mm joint

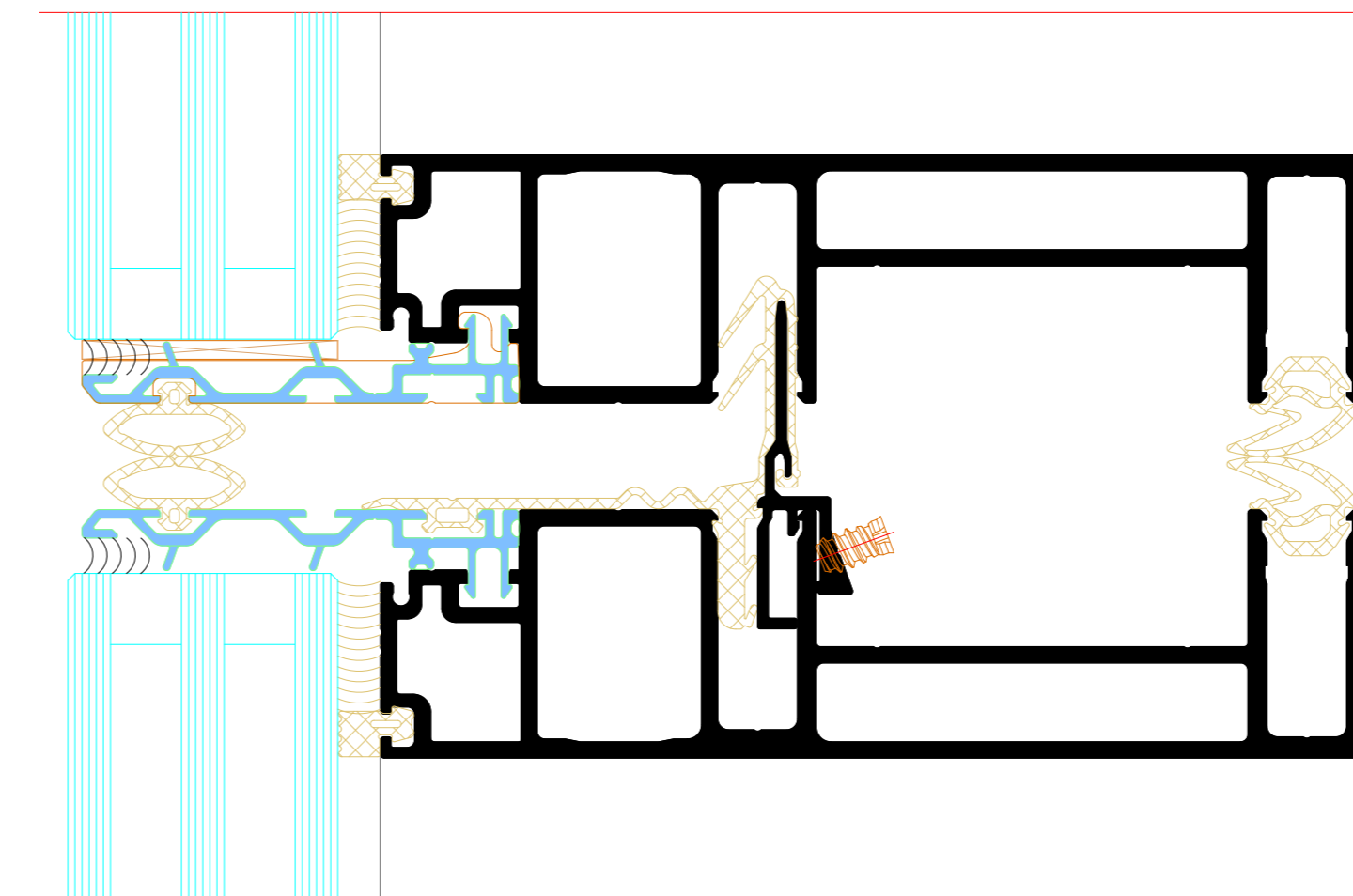

Vertikalschnitt durch Sprosse AF UDC 80 SG, Direktverklebung
Vertical section detail through AF UDC 80 SG sash bar, direct bonding

20 mm Fuge
20 mm joint

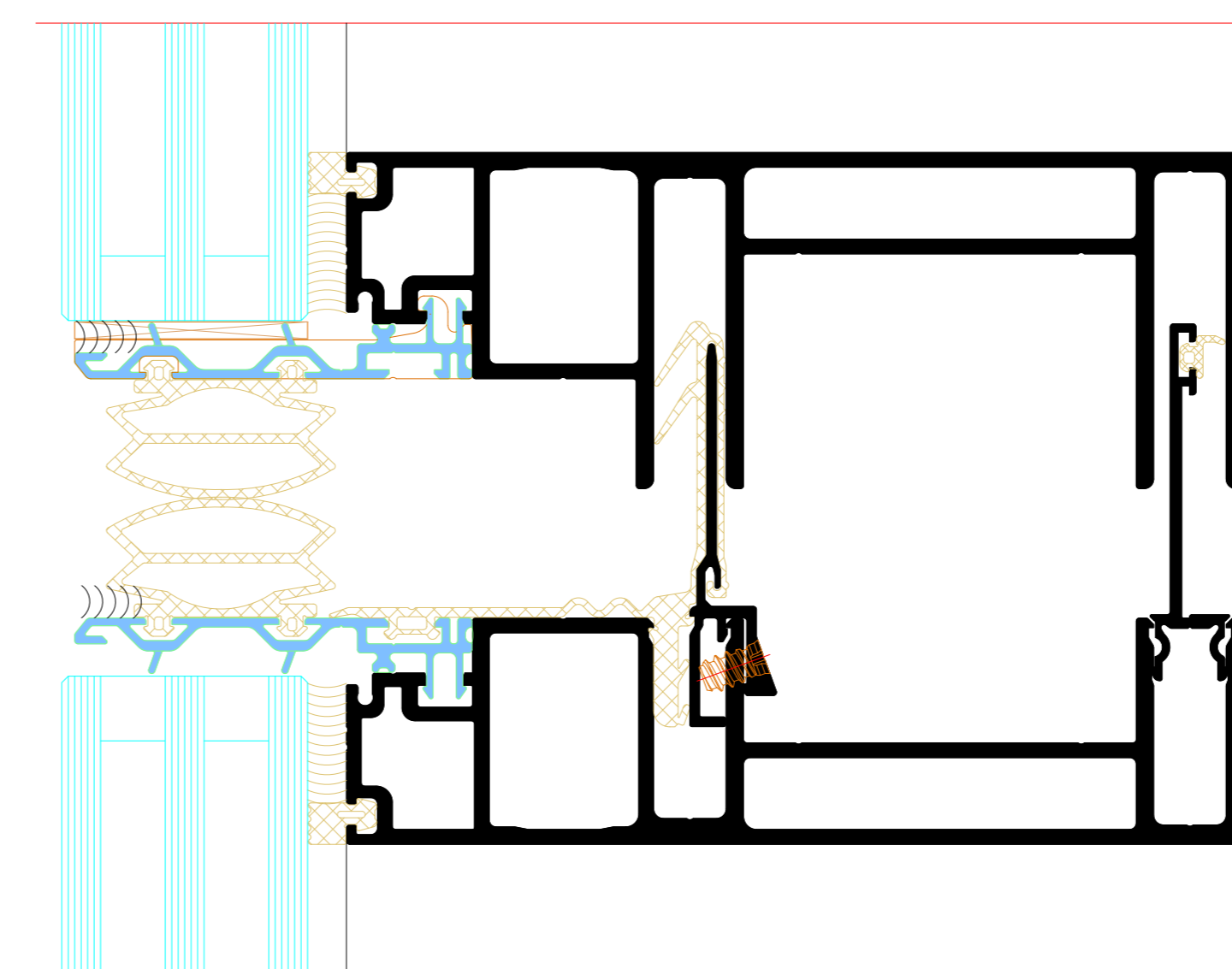

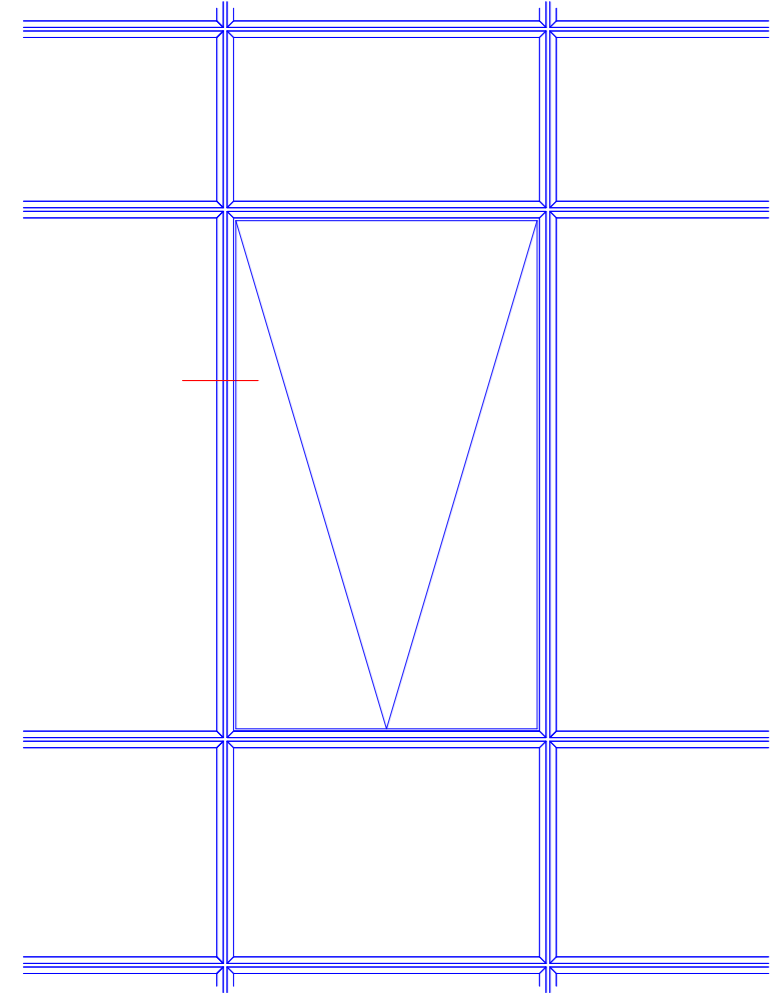

Horizontalschnitt durch Rahmen AF UDC 80 SG mit Einselelement AWS 114 SG.SI
Horizontal section detail through AF UDC 80 SG with AWS 114 SG.SI insert unit

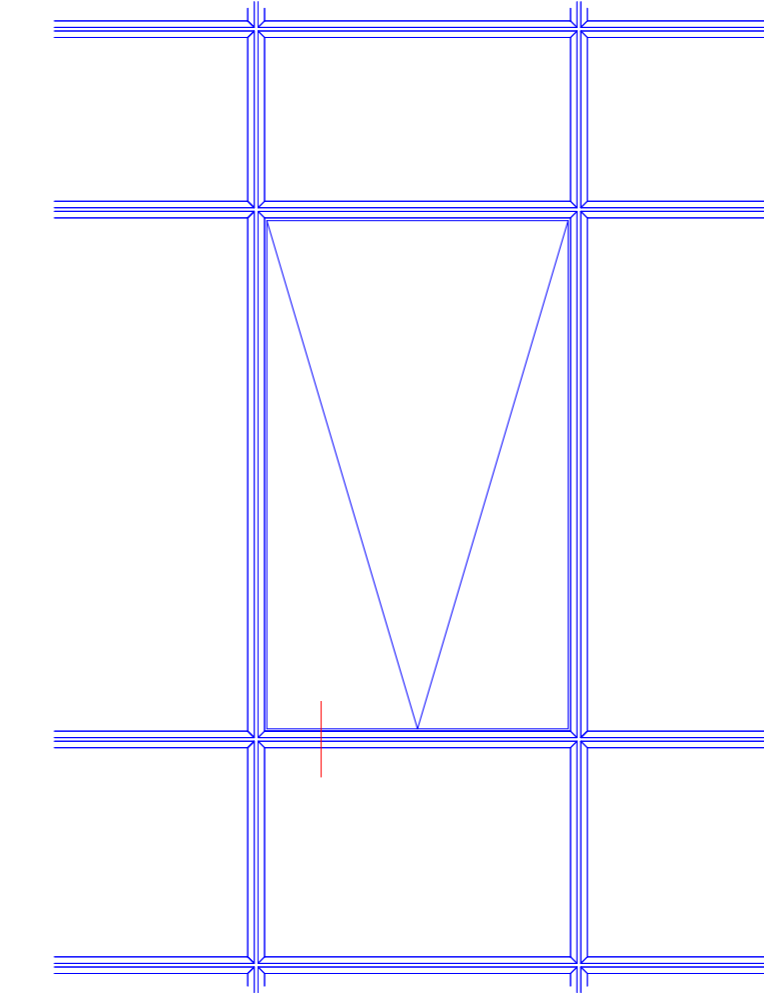
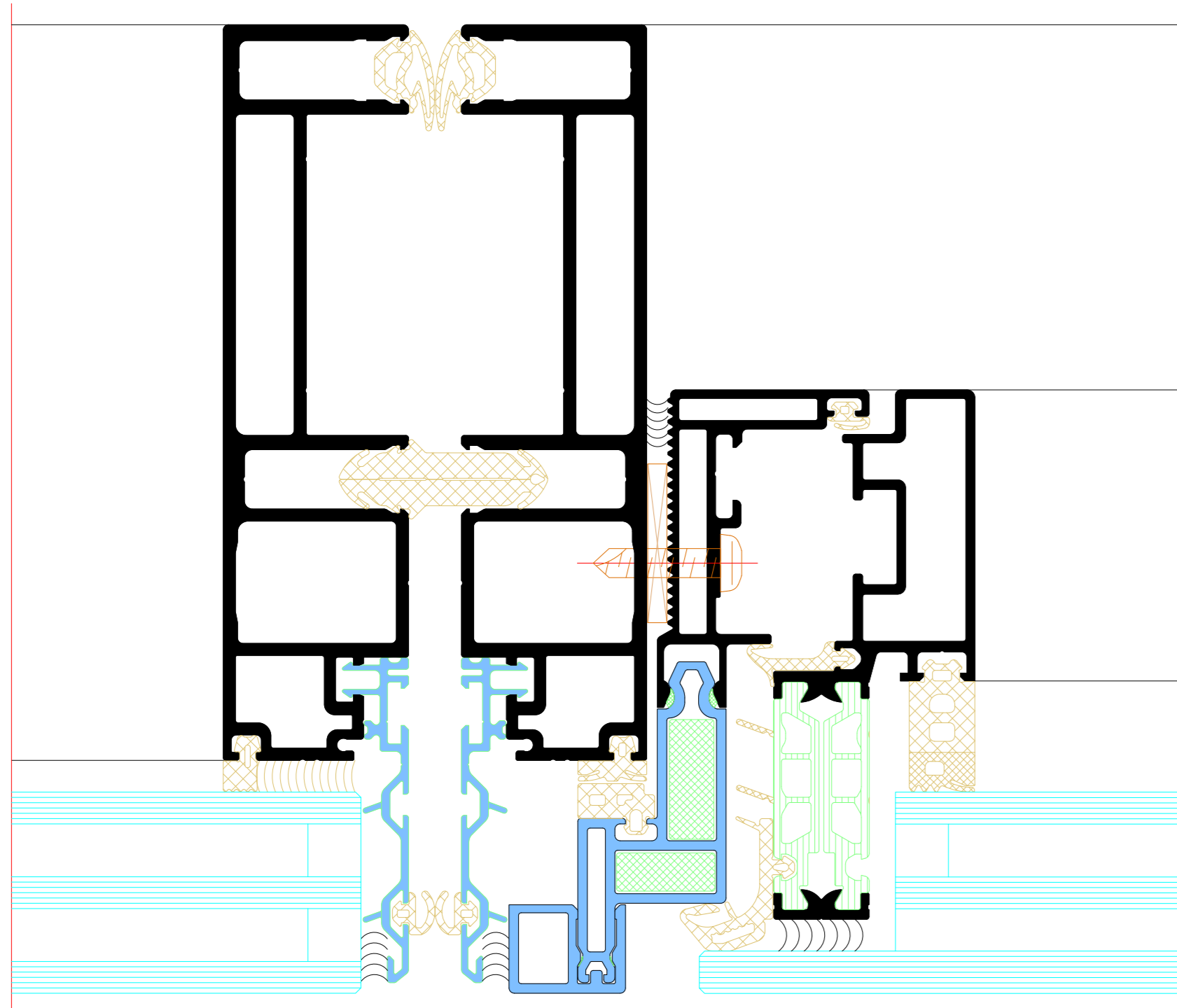

Vertikalschnitt durch Rahmen AF UDC 80 SG mit Einselelement AWS 114.SG.SI
Vertical section detail through AF UDC 80 SG with AWS 114.SG.SI insert unit

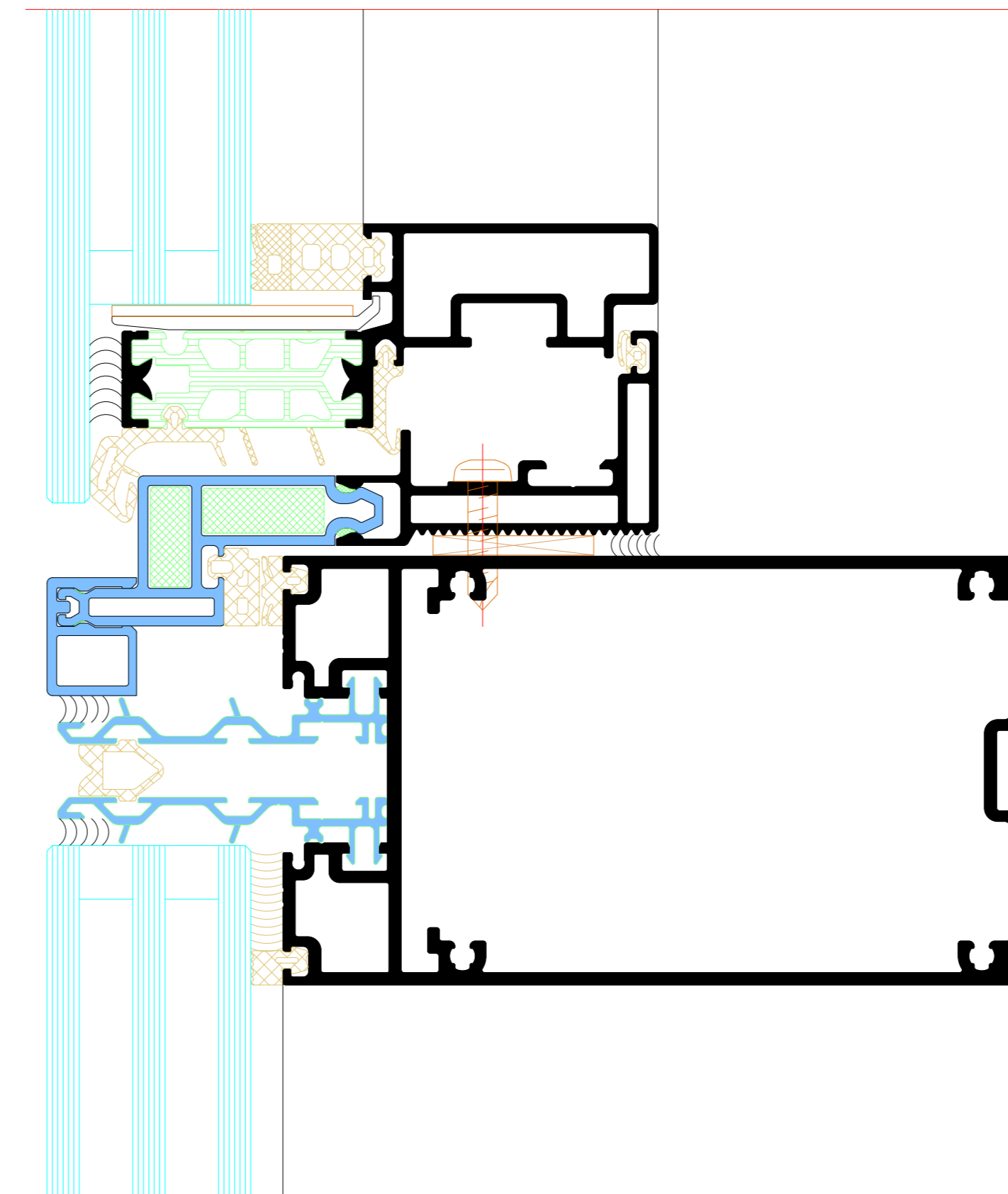

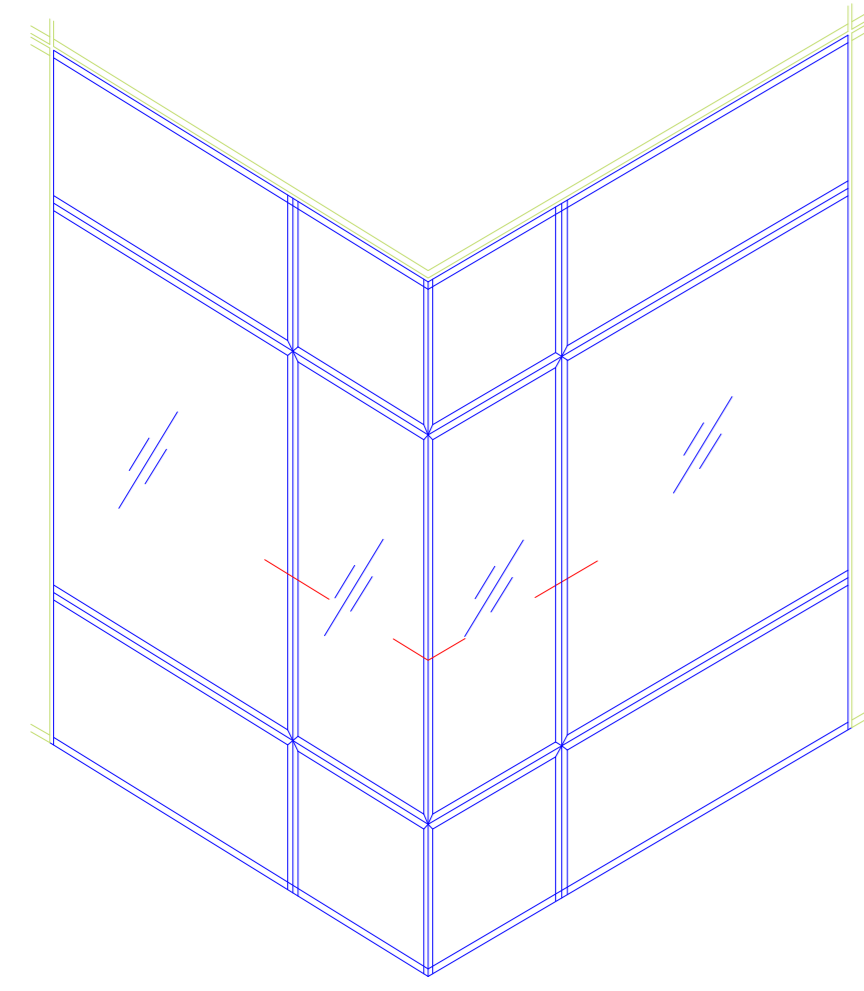

Horizontalschnitt durch AF UDC 80 SG 90°-Außenecke
Horizontal section detail through AF UDC 80 SG outer corner

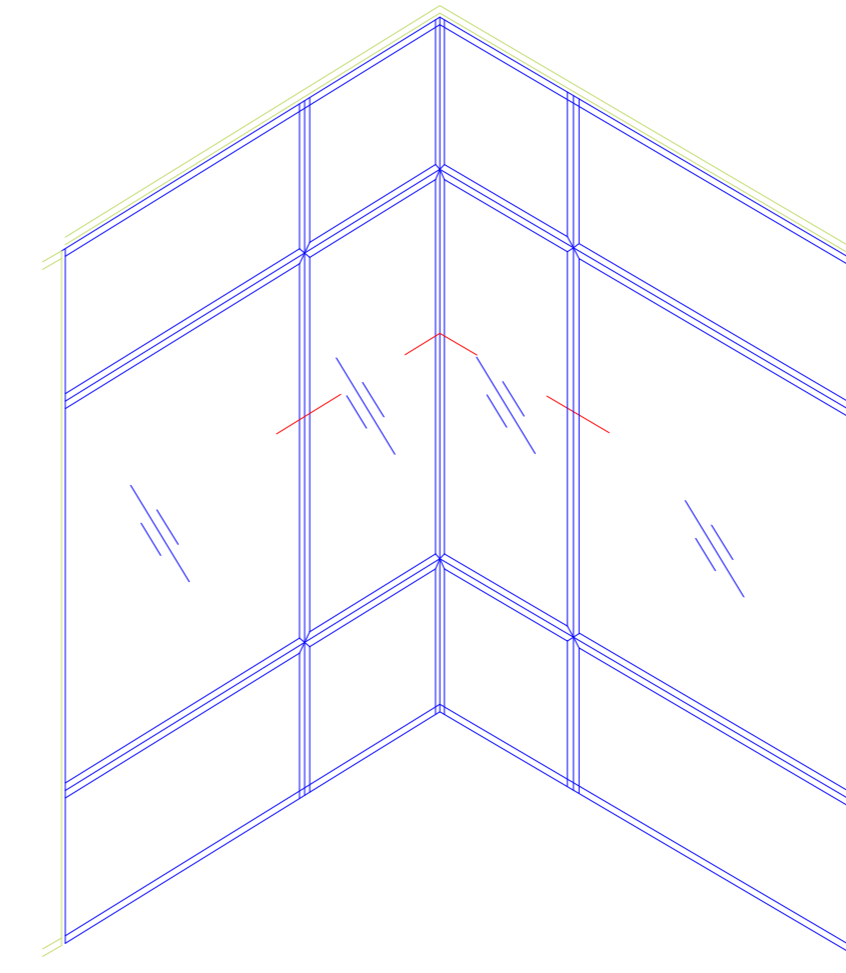
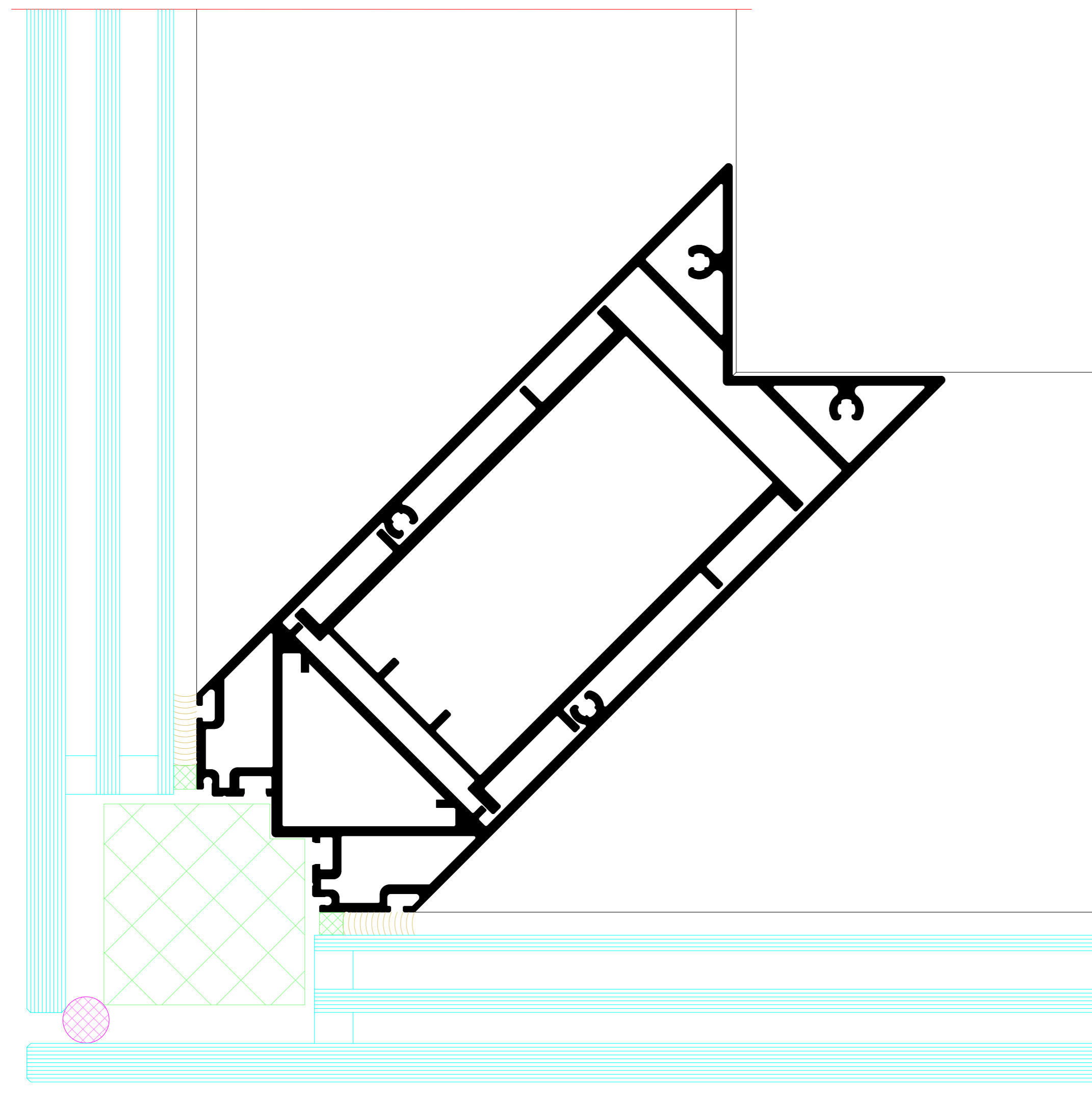

Horizontalschnitt durch AF UDC 80 SG 90°-Innenecke
Horizontal section detail through AF UDC 80 SG inner corner

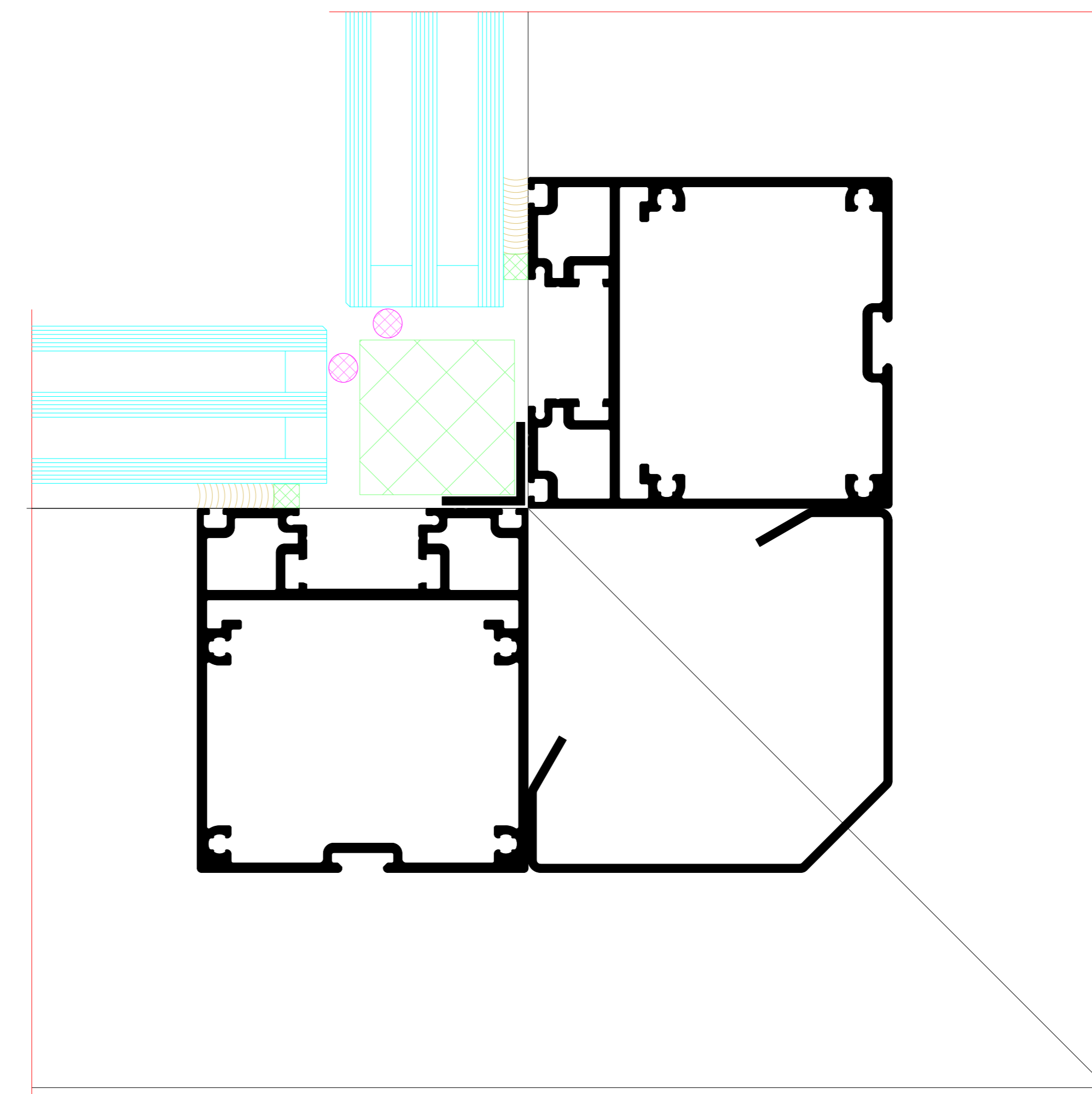

Rahmenprofile für Verklebung mit Glaswechselrahmen

Frame profiles for bonding with glass replacement frame

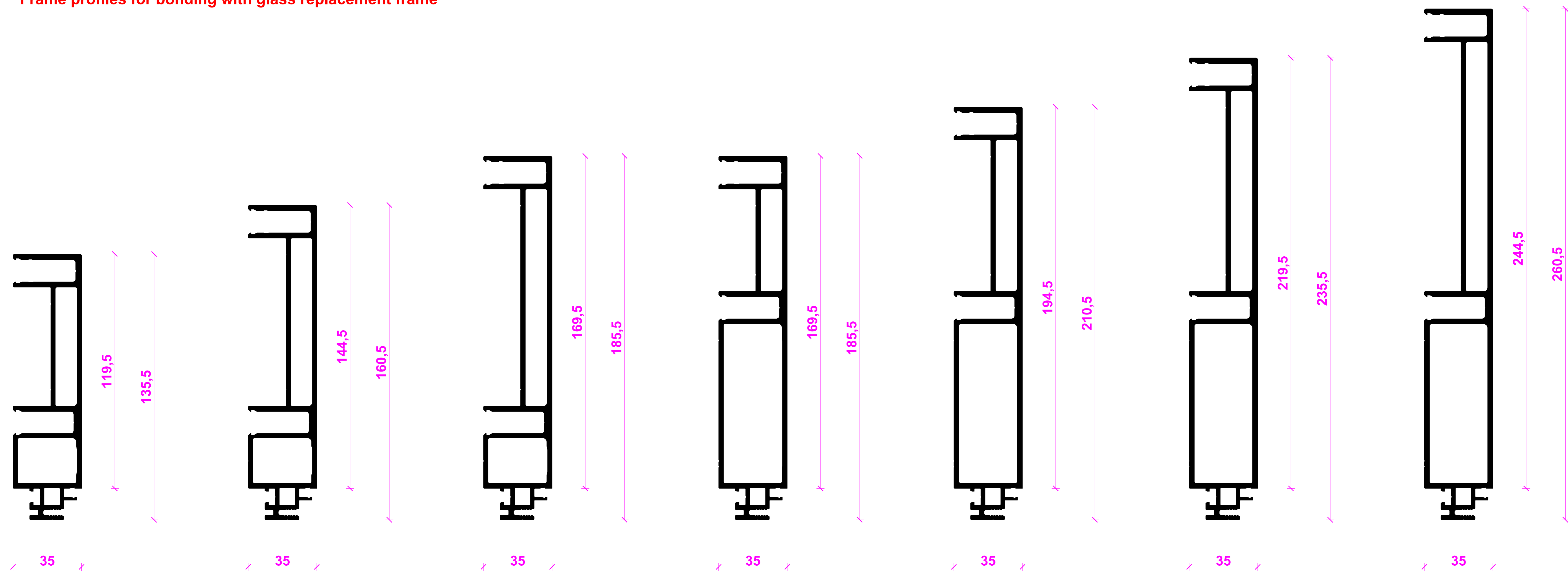

Rahmenprofile für Verklebung mit Glaswechselrahmen

Frame profiles for bonding with glass replacement frame

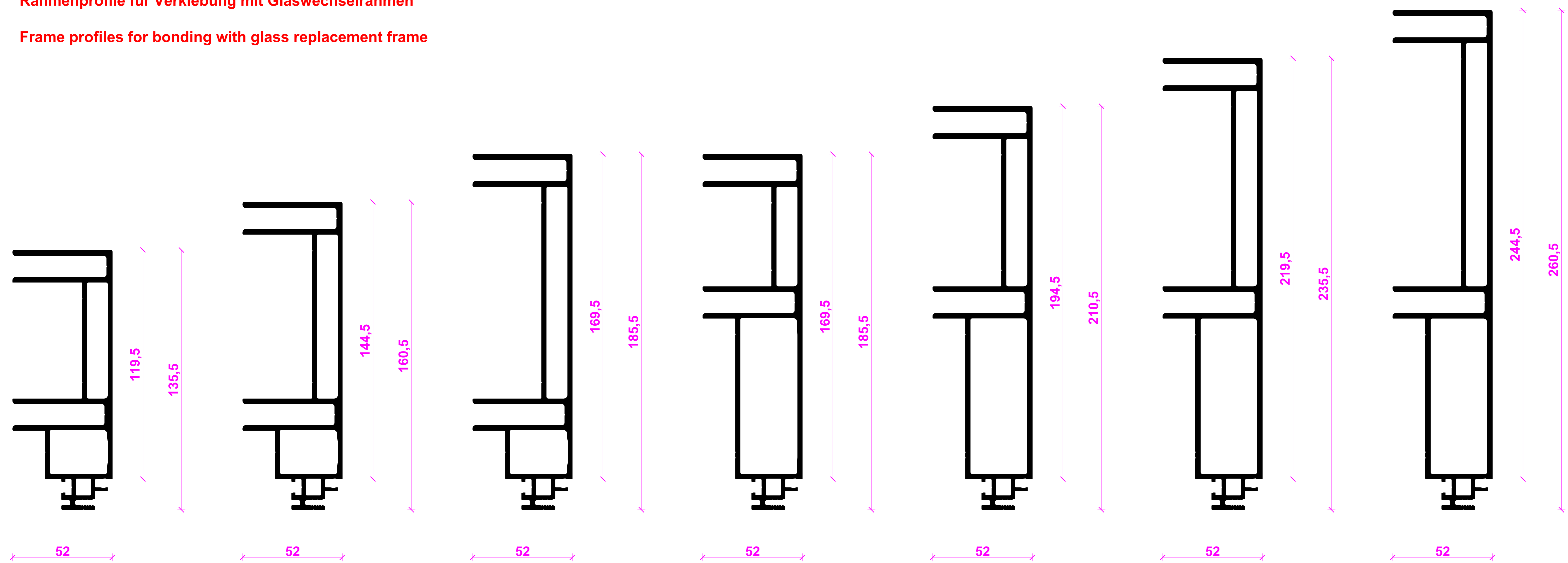

Rahmenprofile für ETA-Verklebung und Direktverklebung

Frame profiles for ETA bonding and direct bonding

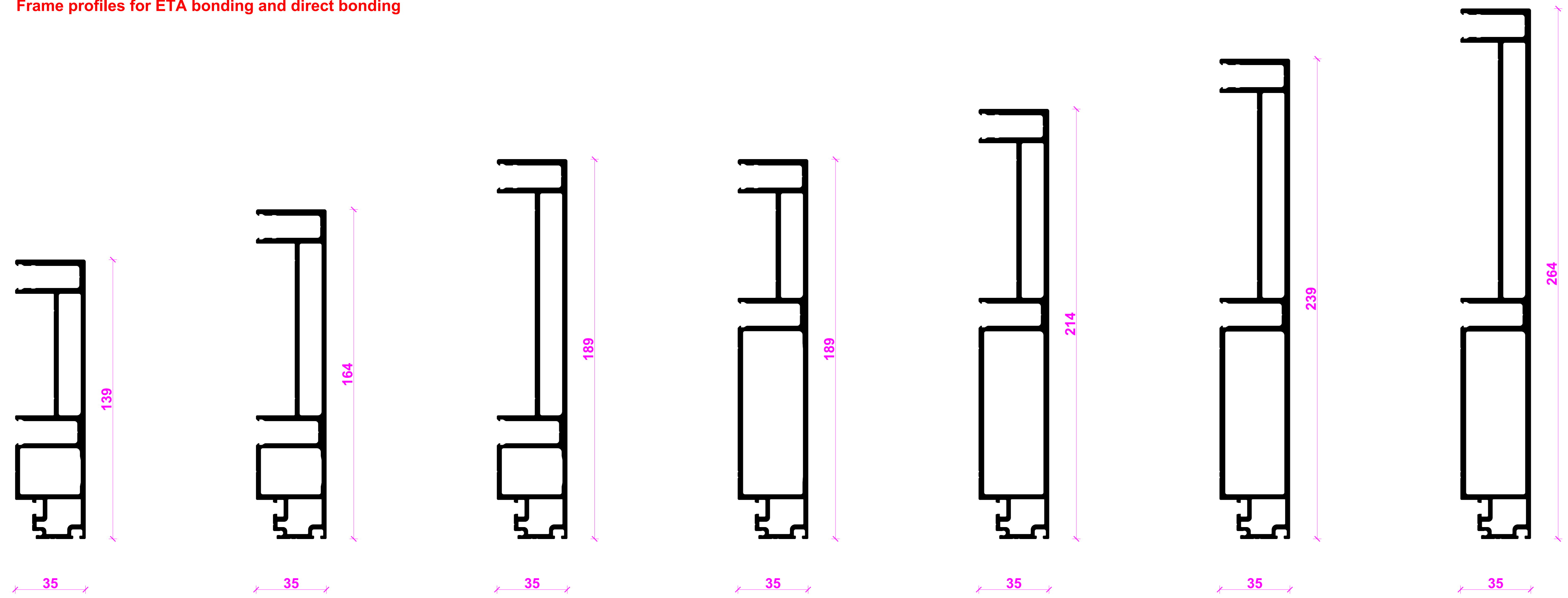

Rahmenprofile für ETA-Verklebung und Direktverklebung

Frame profiles for ETA bonding and direct bonding

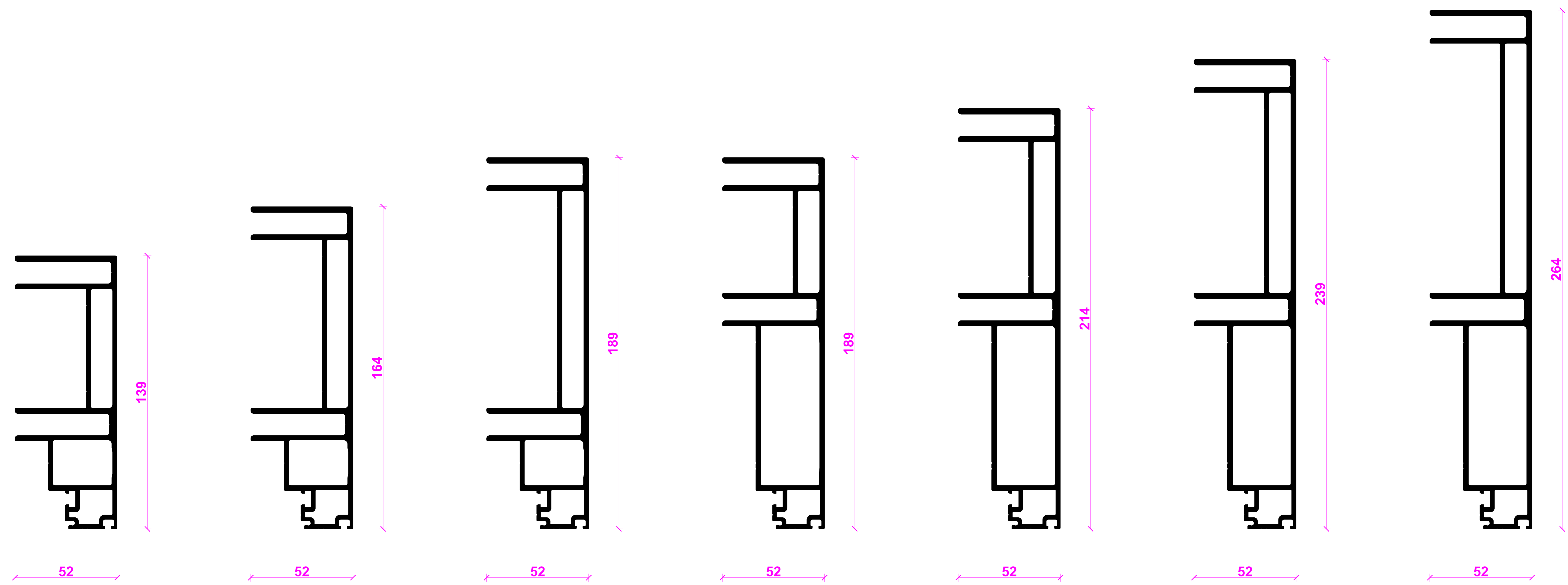

Sprossenprofile für Verklebung mit Glaswechselrahmen

Sash bar profiles for bonding with glass replacement frame

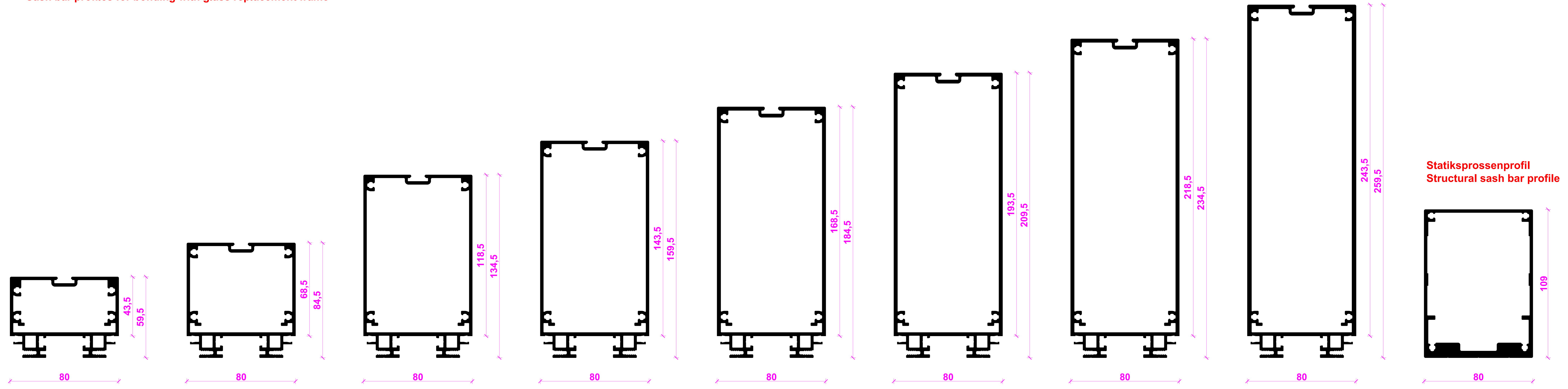

Rahmenprofile für ETA-Verklebung und Direktverklebung

Frame profiles for ETA bonding and direct bonding

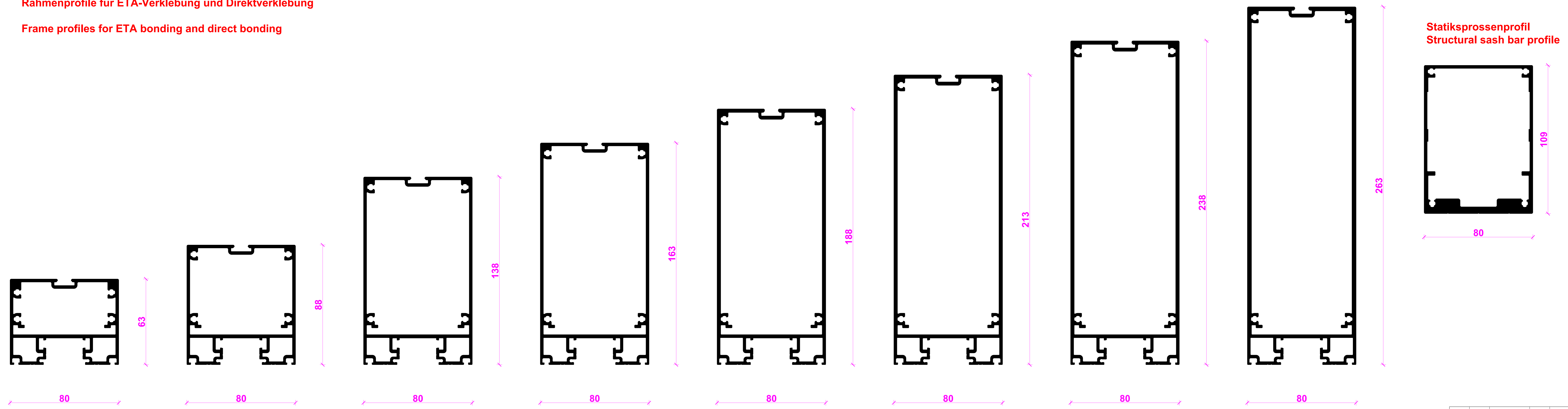

| Code | Titel | Version | Gezeichnet | Geprüft | Genehmigt |
|---|-------|---------|------------|---------|-----------|
| 001 | 001 | 001 | 001 | 001 | 001 |
| <p>Riva Profilsysteme Riva Profile systems</p> <p>Hersteller Fassade RIVA AF UDC 80 SG Fassade RIVA AF UDC 80 SG</p> <p>Produkt Fassade RIVA AF UDC 80 SG</p> <p>Produktname Fassade RIVA AF UDC 80 SG</p> <p>Produktcode Fassade RIVA AF UDC 80 SG</p> <p>Produkttyp Fassade RIVA AF UDC 80 SG</p> <p>Produktgruppe Fassade RIVA AF UDC 80 SG</p> <p>Produktfamilie Fassade RIVA AF UDC 80 SG</p> <p>Produktlinie Fassade RIVA AF UDC 80 SG</p> <p>Produktserie Fassade RIVA AF UDC 80 SG</p> <p>Produktvariante Fassade RIVA AF UDC 80 SG</p> <p>Produktmodell Fassade RIVA AF UDC 80 SG</p> <p>Produktfarbe Fassade RIVA AF UDC 80 SG</p> <p>Produktmaterial Fassade RIVA AF UDC 80 SG</p> <p>Produktgewicht Fassade RIVA AF UDC 80 SG</p> <p>Produktlänge Fassade RIVA AF UDC 80 SG</p> <p>Produktbreite Fassade RIVA AF UDC 80 SG</p> <p>Produkthöhe Fassade RIVA AF UDC 80 SG</p> <p>Produktvolumen Fassade RIVA AF UDC 80 SG</p> <p>Produktfläche Fassade RIVA AF UDC 80 SG</p> <p>Produktperimeter Fassade RIVA AF UDC 80 SG</p> <p>Produktinhalt Fassade RIVA AF UDC 80 SG</p> <p>Produktbestand Fassade RIVA AF UDC 80 SG</p> <p>Produktstatus Fassade RIVA AF UDC 80 SG</p> <p>Produkttypcode Fassade RIVA AF UDC 80 SG</p> <p>Produktgruppencode Fassade RIVA AF UDC 80 SG</p> <p>Produktfamiliecode Fassade RIVA AF UDC 80 SG</p> <p>Produktliniecode Fassade RIVA AF UDC 80 SG</p> <p>Produktseriecode Fassade RIVA AF UDC 80 SG</p> <p>Produktvariante Fassade RIVA AF UDC 80 SG</p> <p>Produktmodellcode Fassade RIVA AF UDC 80 SG</p> <p>Produktfarbencode Fassade RIVA AF UDC 80 SG</p> <p>Produktmaterialcode Fassade RIVA AF UDC 80 SG</p> <p>Produktgewichtcode Fassade RIVA AF UDC 80 SG</p> <p>Produktlänge Fassade RIVA AF UDC 80 SG</p> <p>Produktbreite Fassade RIVA AF UDC 80 SG</p> <p>Produkthöhe Fassade RIVA AF UDC 80 SG</p> <p>Produktvolumen Fassade RIVA AF UDC 80 SG</p> <p>Produktfläche Fassade RIVA AF UDC 80 SG</p> <p>Produktperimeter Fassade RIVA AF UDC 80 SG</p> <p>Produktinhalt Fassade RIVA AF UDC 80 SG</p> <p>Produktbestand Fassade RIVA AF UDC 80 SG</p> <p>Produktstatus Fassade RIVA AF UDC 80 SG</p> <p>Produkttypcode Fassade RIVA AF UDC 80 SG</p> <p>Produktgruppencode Fassade RIVA AF UDC 80 SG</p> <p>Produktfamiliecode Fassade RIVA AF UDC 80 SG</p> <p>Produktliniecode Fassade RIVA AF UDC 80 SG</p> <p>Produktseriecode Fassade RIVA AF UDC 80 SG</p> <p>Produktvariante Fassade RIVA AF UDC 80 SG</p> <p>Produktmodellcode Fassade RIVA AF UDC 80 SG</p> <p>Produktfarbencode Fassade RIVA AF UDC 80 SG</p> <p>Produktmaterialcode Fassade RIVA AF UDC 80 SG</p> <p>Produktgewichtcode Fassade RIVA AF UDC 80 SG</p> | | | | | |

Aufsatzprofil für Verklebung mit Glaswechselrahmen
Add-on profile for bonding with glass replacement frame

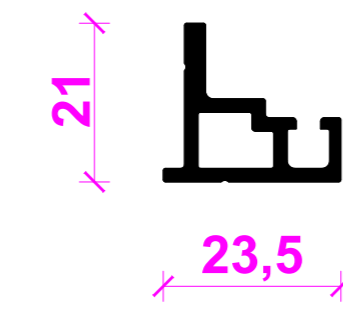
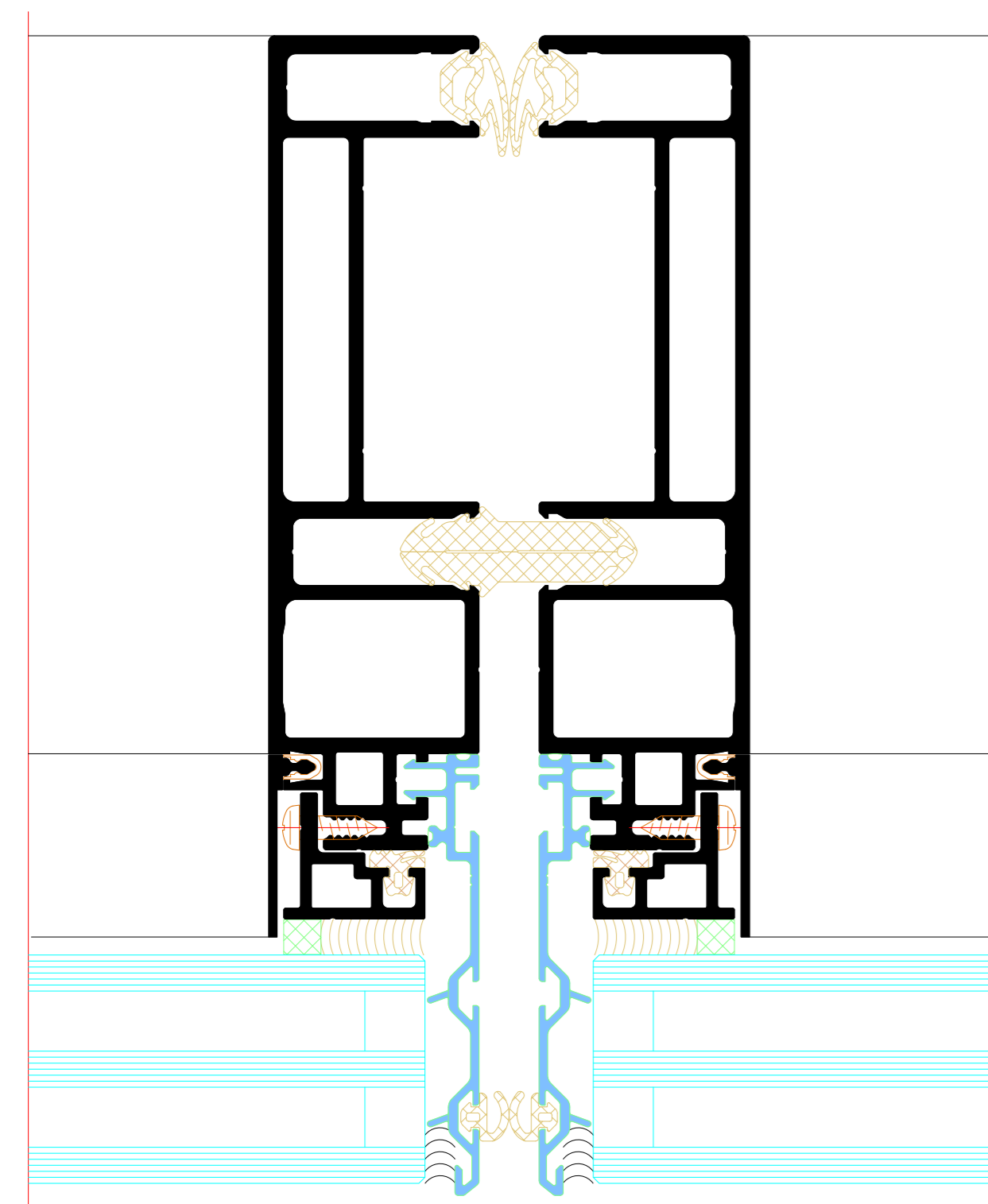

Adapterprofil für Verklebung nach den Richtlinien der ETA
Adapter profile for bonding in accordance with ETA guidelines

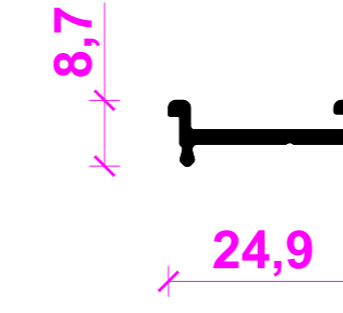
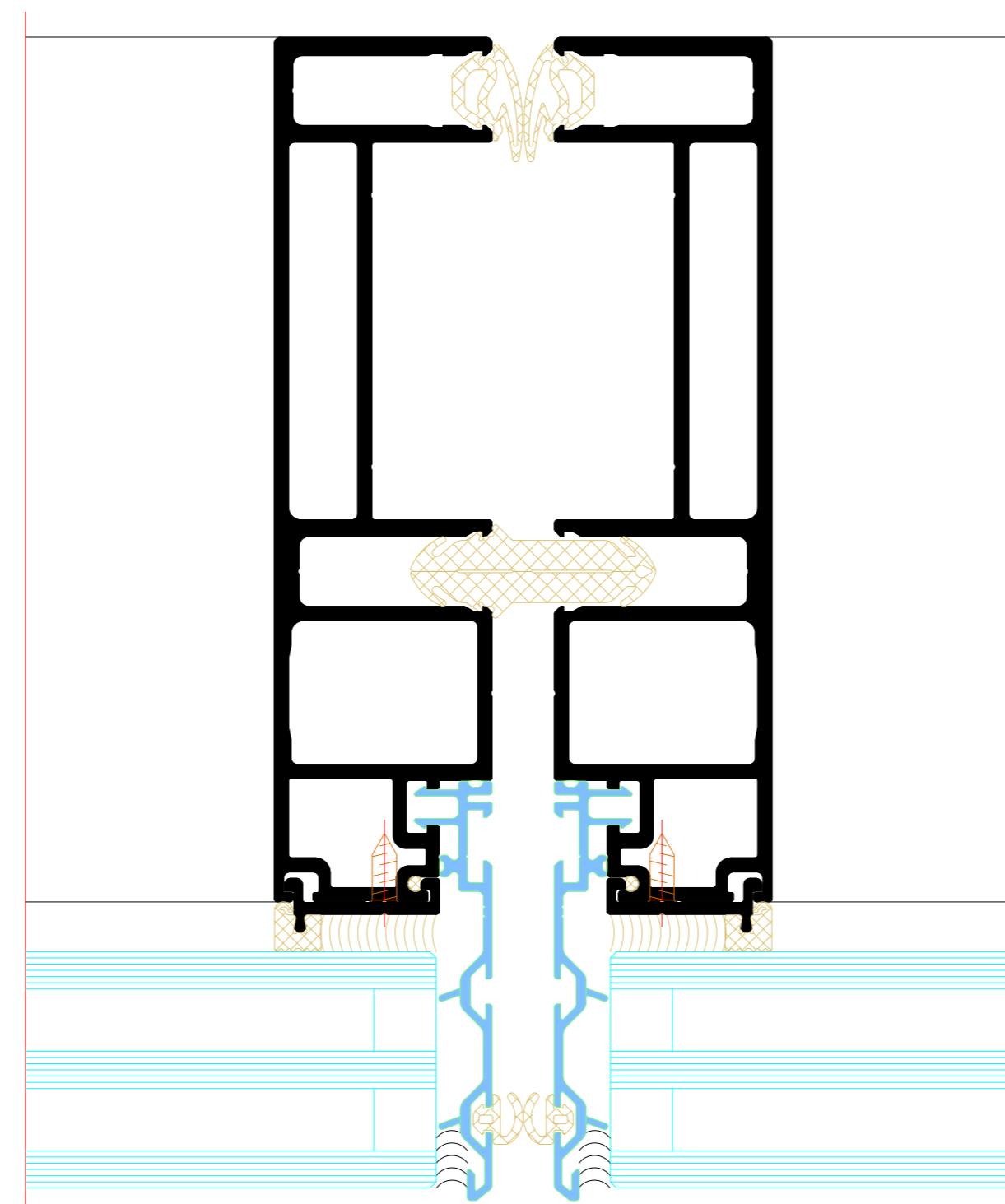

Zusatzprofile
Supplementary profiles

Blende für Aufsatzprofil
Cover for add-on profile

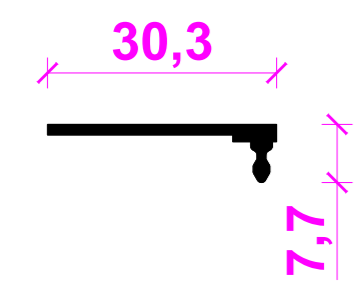

Blende für Aufsatzprofil (Eckpfosten)
Cover for add-on profile (corner mullion)

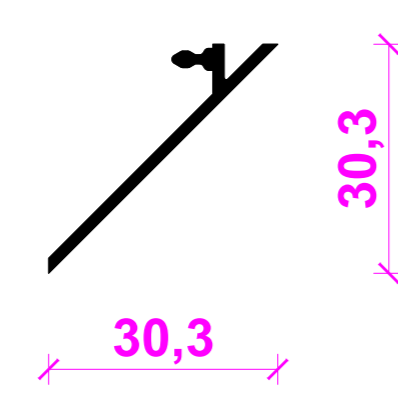

Ausgleichsprofil für Glaswechselrahmen
Spacer profile for glass replacement frame

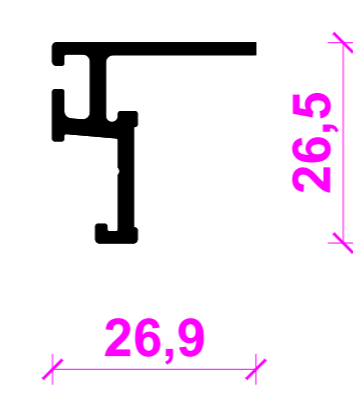

Kaltbrüstungsprofile
Ventilated spandrel profiles

